

# **TRIBRID SPEED DOME CAMERA**

## **System Configuration Guide**

Compatible with TVI, AHD and IP systems

The product image shown above may differ from the actual product.  
Please use this camera with a DVR which supports HD video recording.  
Please read the instructions thoroughly before using the product.

## IMPORTANT SAFEGUARD



### CAUTION

**RISK OF ELECTRIC SHOCK**



#### CAUTION:

To reduce the risk of electric shock, do not expose this apparatus to rain or moisture.

Only operate this apparatus from the type of power source indicated on the label.

The company shall not be liable for any damages arising out of any improper use, even if we have been advised of the possibility of such damages.



The lightning flash with arrowhead symbol, within an equilateral triangle, is intended to alert the user to the presence of uninsulated "dangerous voltage" within the product's enclosure that may be of sufficient magnitude to constitute a risk of electric shock to persons.



This exclamation point within an equilateral triangle is intended to alert the user to the presence of important operating and maintenance (servicing) instructions in the literature accompanying the appliance.



#### ROHS Announcement

All lead-free products offered by the company comply with the requirements of the European law on the Restriction of Hazardous Substances (RoHS) directive, which means our manufacture processes and products are strictly "lead-free" and without the hazardous substances cited in the directive.



The crossed-out wheeled bin mark symbolizes that within the European Union the product must be collected separately at the product end-of-life. This applies to your product and any peripherals marked with this symbol. Do not dispose of these products as unsorted municipal waste.



#### CE Mark

This apparatus is manufactured to comply with the radio interference.

The company does not warrant that this manual will be uninterrupted or error-free. We reserve the right to revise or remove any content in this manual at any time.

# TABLE OF CONTENTS

<b>1. OVERVIEW</b> .....	<b>1</b>
1.1 FEATURES .....	1
1.2 PACKAGE CONTENT .....	2
1.3 DIMENSIONS .....	2
1.4 CABLE OVERVIEW .....	2
1.5 CAMERA MODE, ID & BAUD RATE SETUP .....	3
<i>WHERE TO SET</i> .....	3
<i>SET TO IP CAMERA</i> .....	3
<i>SET TO TVI CAMERA</i> .....	3
<i>SET TO AHD CAMERA</i> .....	4
<b>2. PTZ CONTROL</b> .....	<b>5</b>
2.1 VIA HD CCTV DVR / NVR .....	5
2.2 VIA IP CAMERA INTERFACE .....	6
2.3 VIA JOYSTICK AVX102 (OPTIONAL) .....	8
<b>3. CAMERA CONFIGURATIONS – TVI DVR</b> .....	<b>9</b>
3.1 AUTO PAN SETUP .....	11
3.2 CRUISE SETUP .....	12
3.3 SEQUENCE SETUP .....	13
3.4 CAMERA GUARD .....	15
3.5 HOME SETUP .....	16
3.6 AUTO TRACKING SETUP .....	17
<b>4. CAMERA CONFIGURATIONS – IP CAMERA</b> .....	<b>18</b>
4.1 DIGITAL PTZ (DPTZ) OPERATIONS .....	18
4.2 EVENT RECORD SEARCH & PLAYBACK .....	19
4.3 SYSTEM CONFIGURATION .....	20
4.3.1 <i>Network</i> .....	22
4.3.2 <i>Camera</i> .....	29
4.3.3 <i>VA</i> .....	35
4.3.4 <i>Record</i> .....	36
4.3.5 <i>Storage</i> .....	37
4.3.6 <i>Trigger</i> .....	37
4.3.7 <i>General</i> .....	40
<b>SPECIFICATIONS*</b> .....	<b>45</b>
<b>MICRO SD CARD COMPATIBLE LIST</b> .....	<b>47</b>
<b>API ID APPLICATION FOR SMS MESSAGING</b> .....	<b>48</b>
<b>PREREQUISITES FOR NETWORK SHARE</b> .....	<b>50</b>
CHECK PC IP ADDRESS .....	50
CREATE "ADMINISTRATOR" ACCOUNT .....	51
SHARE FOLDER .....	52

# 1. OVERVIEW

## 1.1 FEATURES

- Tribrid video output of **IP**, **TVI** and **AHD** to fulfill different customers' requirements
- **PTZ control** for seamless monitoring:
  - Capable of **360° pan rotation continuously** with the **tilt movement of -6° ~ 90°**, allowing quick and smooth action of the camera lens
  - **Auto Tracking** to follow moving objects
  - **Hot Point** support to quickly move the camera to the specified point remotely
  - Up to **256 preset points & four sequence groups** programmable for multiple points monitoring, and **auto pan**
- **External alarm I/O device** connection



- **ONVIF** (**ONVIFS**) standard supported to simplify system integration
- **WDR** to increase image recognizability in overexposure and dark areas
- **(For IP camera mode only)** MicroSD card support (up to 64GB) for **video storage**
- **(For IP camera mode only)** **Line in / out** jacks available for audio transmission
- IR effective range up to **200 meters** for night surveillance. When **IR Turbo** mode is on, the effective range could be more than 200 meters.
- **IP66** for outdoor application
- **Remote Surveillance**
  - **Fully compatible** with **iOS** and **Android** devices, and **Internet Explorer** on Windows operating system
  - **Push Video** available on your iOS and Android devices when used with Push Video NVR series

## 1.2 PACKAGE CONTENT

- Camera
- User manual
- Bracket (w/carabiner)
- Terminal block

## 1.3 DIMENSIONS

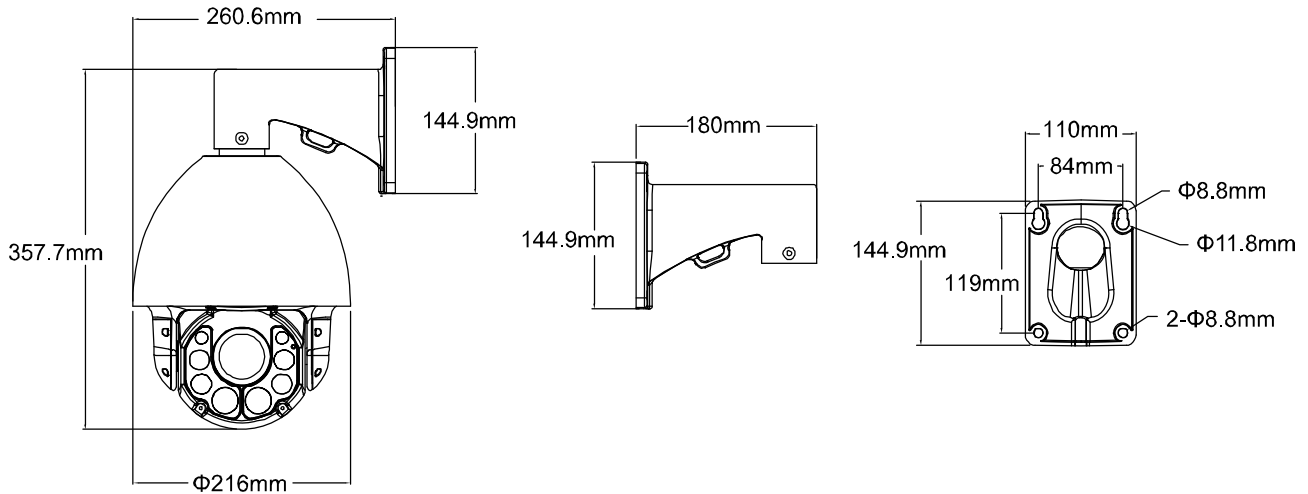

\*Dimensional Tolerance: ± 5mm

## 1.4 CABLE OVERVIEW

Cable	Description
Power cable	Connect to the supplied adapter.
BNC cable	Connect to an HD CCTV DVR with a coaxial cable (Used as an HD CCTV camera).
Terminal block	
1. ALARM IN	Alarm input for an alarm device like magnetic contacts.
2. ALARM OUT	Alarm output for an alarm device like a siren.
3. GND	Ground wire
4. RS485A	Used for PTZ camera or other device connection.
5. RS485B	Used for PTZ camera or other device connection.
RJ45 network cable	Connect to an NVR with a RJ45 network cable or directly connect to a router (Used as an IP camera).
Line in*	Colored as blue, used to connect to a microphone for audio input.
Line out*	Colored as green, used to connect to a speaker for audio output.
RESET	Remove the insulating coating of wire, and twist it with a ground wire together to reset default camera
GND	Ground wire

\* The audio function is available only when this camera is used as an IP camera.

## 1.5 CAMERA MODE, ID & BAUD RATE SETUP

This camera could be used as an IP camera, a TVI camera and an AHD camera. Before connecting this camera to any recorder, you may need to manually set the camera mode, ID & baudrate for the camera to work properly. Please check the description below for details.

---

**NOTE:** The on / off of the DIP switch is shown as white.

---

### ■ WHERE TO SET

Remove the panel as indicated below to find the dip switch.

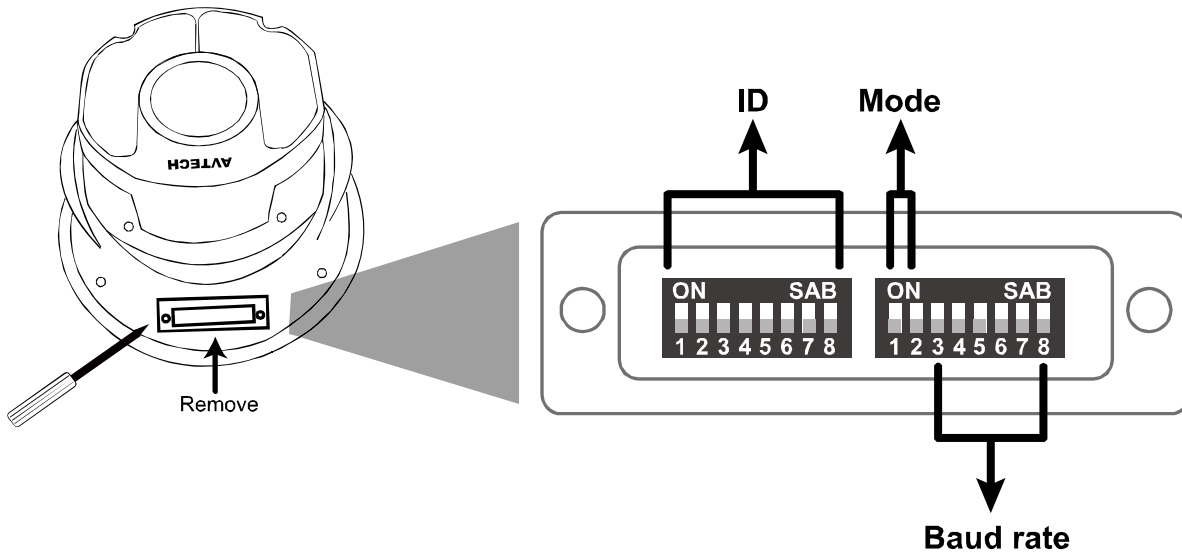

### ■ SET TO IP CAMERA

**Mode:** Mode: IP + CVBS  
 1 = ON  
 2 = ON



Mode: IP + Audio  
 1 = OFF  
 2 = OFF



### ■ SET TO TVI CAMERA

**Mode:** Mode: TVI  
 1 = OFF  
 2 = ON



You might need to set the ID and baud rate if you're connecting to other brand's TVI DVR:

**ID:** The ID number can be set from 0~255 (binary). Please check the examples below.

Default ID: 0      ID: 76      ID: 8



**Baud Rate:**

2400	4800	9600
19200	38400	

■ **SET TO AHD CAMERA**

**Mode:** Mode: AHD

1 = ON  
2 = OFF

You might need to set the ID and baud rate if you're connecting to other brand's AHD DVR:

**ID:** The ID number can be set from 0~255 (binary).  
Please check the examples below.

Default ID: 0	ID: 76	ID: 8

**Baud Rate:**

2400	4800	9600
19200	38400	









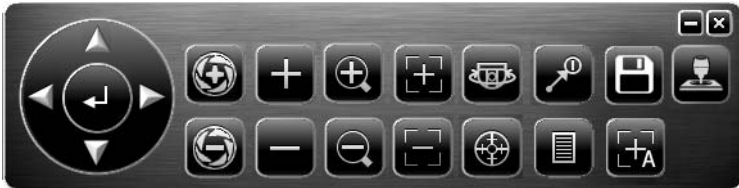





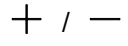

## 2. PTZ CONTROL

### 2.1 VIA HD CCTV DVR / NVR

**NOTE:** The panel below is available only when the camera is used with our brand's HD CCTV DVR or NVR, and not all functions in the panel are supported for this camera.

Right-click to return to the live view, and click the channel with this speed dome camera connected. Then, click  on the bottom left side of the screen to show the PTZ control panel.



	Up / Down / Left / Right	Click the arrow keys (  /  /  /  ) to move the camera lens up / down / left /right.
	Zoom in / out max	Click to zoom in on the image to the largest / zoom out on the image to its original size.
	Zoom in / out	Click to zoom in / out the image.
	Focus near / far	Click to adjust the focus of the image.
	Auto mode	Click to activate the auto function. Before using it, you need to assign a specific function that will be enabled when "  " is clicked. For details, please see " <b>3.1 AUTO PAN SETUP</b> ".
	Auto tracking	Click to start auto tracking, and click again to stop.
	Preset point	Click to configure or go to the preset point you want to see. For details, please see " <b>3.3 SEQUENCE SETUP</b> ".
	Auto Focus	Click to automatically adjust the focus of the camera.
	Joystick	Click to enable faster and smoother pan / tilt movement of the camera than to simply move by the arrow keys (  /  /  /  ). You can also click and hold the mouse to move.

**NOTE:** PTZ control is also available via the optional USB joystick and EagleEyes. For details, please check their respective user manuals.



## 2.2 VIA IP CAMERA INTERFACE

When this camera is individually used and is not connected to any NVR, PTZ control can be done via the interface of the camera.

Step1: Open your web browser, and key in <http://ipaddress:portnum> in the URL address box.

For example, for the IP address 60.121.46.236 and port No. 888, please key in "http://60.121.46.236:888" into the URL address box, and press "Enter".

Step2: In the login page, key in the user name and password, and enter the security code from the image below if any. Then, click "LOGIN".

Step3: The wizard is then started.

- To skip the wizard and directly access the camera live view, click "Close".
- To directly access the camera live view without starting the wizard for the login next time, check "Do not start wizard at login".

---

**Note:** If you're prompted to install "VLC player", "Software" or "H264 Streaming Viewer", please agree to proceed the installation. Or, you might not be able to see the live view properly.

---













Step4: When the login is successful, the live view is shown.

---

**Note:** The buttons available depend on the camera model you have, and the user level used to log in.

---

The screenshot displays the web interface for an H.264 IP camera. On the left is a control panel with a PTZ (Pan/Tilt/Zoom) joystick, a numeric keypad for presets, and various control buttons. The main area shows a live video feed of an office. A red box highlights the 'Current Streaming Information' at the top of the video frame, with a red arrow pointing to a legend: FR: Frame rate, DR: Data rate, Time: Current system time, Q: Quality, R: Resolution. The video frame also shows 'Zoom x3, DZ' and 'Zoom x1, DZ x1' text. Red arrows indicate 'Horizontal move' and 'Vertical move' capabilities. The interface includes a 'Live View Panel' and a 'Zoom' slider at the bottom.

Function	Icon	Description
Config.		Switch to the system configuration page, and the functions available for “Supervisor” and “Power User” are different. For details, please refer to the user manual.
Arrow keys panel	--	Click to move the camera lens up / up-left / down / up-right / left / down-right / right / down-left.
Preset points	--	Click the numbering of the preset point you want to move the PTZ camera to the selected preset point. To set preset points, please go to “Config”. For details, please refer to the user manual.
Zoom-in / out	 / 	Click to zoom in / out the current image.
Max. Zoom-in / out	 / 	Click to zoom in the image to the largest / zoom out the image to its original size.
Focus near / far	 / 	Click to adjust the clearness of the video images.
DPTZ		Click to enable digital PTZ functions with zoom-in ratio up to 16X.
Auto Tracking		Click to activate the auto tracking function. For setting details, please go to “Config”. For details, please refer to the user manual.
Auto Mode		Click to activate the auto function. Before using it, you need to assign a specific function that will be enabled when “AUTO” is clicked. For details, please refer to the user manual. <i>This function will be disabled when DPTZ is enabled.</i>
Focus Zone		Click to assign the point for focus adjustment. <i>This function will be disabled when DPTZ is enabled.</i>
Auto Move		Click to enable the auto move function. It allows the camera to move to the direction where your cursor stays. <i>This function will be disabled when DPTZ is enabled.</i>

### **Pan- / Tilt-Move Manually**

There are three ways to manually move the camera view by:

- Using the arrow key panel
- Hot point – Directly click on the live view to move the camera view.
- Using sliders – Click and drag sliders on the top and left side of the live view to move the camera view.

---

**NOTE:** PTZ control is also available via the optional USB joystick and EagleEyes. For details, please check their respective user manuals.

---

## 2.3 VIA JOYSTICK AVX102 (OPTIONAL)

When this camera is connected to our brand's DVR or NVR, simply plug the joystick to the recorder, switch to the channel which connects this camera and you're ready to control via the joystick.

When this camera is connected remotely via our free PC program, **CMS Lite**, simply plug this joystick to your PC or laptop, switch to the channel which connects this camera, and you're ready to control via the joystick.

---

**NOTE: CMS Lite** could be downloaded from our official website and it's only compatible with Windows XP, Windows Vista, Windows 7 and Windows 8. For details, please check our website.

---

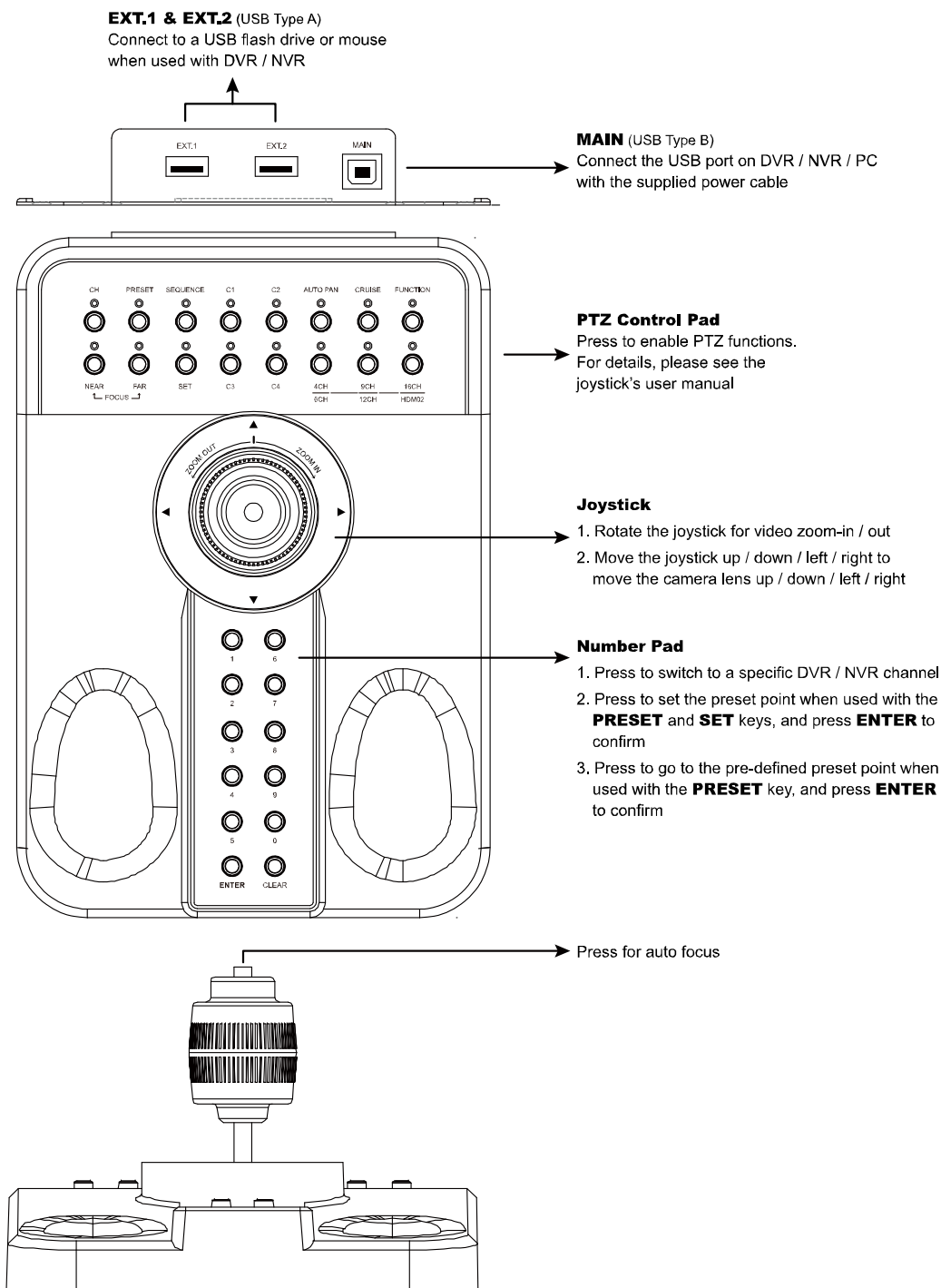

---

**NOTE:** PTZ control is also available via the optional USB joystick and EagleEyes. For details, please check their respective user manuals.

---

### 3. CAMERA CONFIGURATIONS – TVI DVR

**NOTE:** The method below is available only when the camera is used with our brand’s TVI DVR.

On the DVR live view, right click to show the main menu, and select **ADVANCED CONFIG** → **DCCS**. Then, select the channel which connects this camera, and click **SETUP** to enter the menu of camera parameters.

ADVANCED CONFIG				
CAMERA DETECTION ALERT NETWORK DISPLAY RECORD DEVICES <b>DCCS</b> NOTIFY	CH1	CH2	CH3	CH4
	MENU			SETUP
	F.W.			1017
	DEVICE			AVTXXX
	CONNECTION			OK
EXIT				

Item	Description
BRIGHTNESS	Click the current value to manually adjust the brightness of the image. The higher the value, the brighter the image.
CONTRAST	Click the current value to manually adjust the contrast of the image. The higher the value, the higher the contrast ratio.
HUE	Click the current value to manually adjust the hue of the image.
SATURATION	Click the current value to manually adjust the saturation of the image. The higher the value, the more saturated the image.
CAMERA GUARD	Enable "GUARD LOCK" to temporarily disable the pan function of this camera and fix the camera surveillance area. For details, please refer to the section "CAMERA GUARD".
CRUISE MODE	Select the cruise mode when the  is selected in the PTZ mode. There are three options: AUTO PAN, SEQUENCE and CRUISE. AUTO PAN: Pan within the range specified in <b>CRUISE CONFIG</b> . SEQUENCE: Patrol based on the sequence group specified in <b>CRUISE CONFIG</b> . CRUISE: Patrol based on the route recorded in <b>CRUISE CONFIG</b> .
CRUISE CONFIG	The setting shown here depends on what you selected in <b>CRUISE MODE</b> : AUTO PAN: Specify the range for auto pan to run. For details, please refer to the section "AUTO PAN SETUP". SEQUENCE: Configure a sequence group for area patrol. For details, please refer to the section "SEQUENCE SETUP". CRUISE: Customize the patrol route in 200 seconds. For details, please refer to the section "CRUISE SETUP".
AUTO TRACKING	Set the surveillance area for auto tracking, and the tracking timeout. For details, please refer to the section "AUTO TRACKING SETUP".
DISPLAY ZOOM RATIO	Select "ON" to show the zoom ratio on the live view.
PAN SPEED	Set the speed for pan movement.
TILT SPEED	Set the speed for tilt movement.
SPEED BY ZOOM	Select "ON" to automatically adjust the moving speed of the camera in each zoom ratio. In another word, the moving speed in different zoom ratio is different.
HOME	Configure this camera to always return to a specific point when the camera is not operated for the specified time. For details, please refer to the section "HOME SETUP".
VIDEO FORMAT	Select the video format: NTSC / PAL.

Item	Description
WHITE BALANCE	Process the current image to retain color balance over a color temperature range. The options are: AUTO, 2500K, 3200K, 4200K, 5800K & 9500K.
SHARPNESS	Sharpness enhances the clarity of image detail by adjusting the aperture and sharpening the edges in the pictures. Hold and drag the slider to adjust the level of sharpness. The higher the value, the sharper the image.
SLOW SHUTTER	Slow shutter is used to increase the exposure time to get clearer image, for example, at night. The options are: AUTO, 1/15 and 1/6.
IRIS	IRIS is used to adjust the amount of light reaching the image sensor for best image results. The options are: CLOSE, AUTO (default), OPEN, OFF
MIRROR	Select "ON" to rotate the images horizontally based on your installation situation when necessary.
FLIP	Select "ON" to rotate the image 180° when necessary.
3D DENOISE	Click and drag the slider to adjust the level from 0 ~ 5 to decrease the noise shown in the dark environment. 3D denoise analyzes successive pictures to decrease the noise dramatically, but the moving objects might be shown as blurred.
2D DENOISE	Click and drag the slider to adjust the level from 0 ~ 5 to decrease the noise shown in the dark environment. 2D denoise analyzes only a single picture to decrease the noise. The moving objects can remain smooth edges, but the effect might be limited.
EXPOSURE VALUE	Drag the slider to adjust the exposure level from 0 ~ 4.
WIDE DYNAMIC RANGE	Wide Dynamic Range (WDR) is used when users need to increase image recognizability in overexposure and dark areas. The options are: LOW / MIDDLE / HIGH / OFF
FIXED SHUTTER	Shutter Speed is a function that can adjust the duration of the electronic shutter to produce optimum image quality. Select the shutter speed suitable for your environment.
EFLIP	This function is used to keep the image upright always after pan / tilt movement. The options are: OFF / Mechanical.
DAY AND NIGHT	This function is used to configure the day and night mode: Day: Always stay in the day mode (color). Night: Always stay in the night mode (B/W). Sensor: Automatically switch based on the light sensor of the camera. Digital Input N.O. (Used with Alarm In) Normally stay in the day mode, and switch to the night mode when the alarm is triggered. Digital Input N.C. (Used with Alarm In) Normally stay in the night mode, and switch to the day mode the when alarm in triggered.
DEFOG	Select "ON" to enable the defog function in poor weather conditions such as fog, smog or smoke. The captured image can be improved.
MECHANICAL IRIS CALIBRATION	Select "START" to begin mechanical iris calibration.
IR CONTROL	Select "AUTO" to automatically enable IR LEDs at night or in the dark environment, or "OFF" to disable this function.
IR TURN ON LEVEL	Select the level for IR light to activate. 0 ~ 20
IR DELAY TIME	Configure from 1 ~ 60 seconds to delay the switch of the IR mode at night. This is used for the environment where the light condition may change suddenly and usually last for a short time, for example, the entrance of a parking lot. It may cause the day & night mode switching constantly and damage the camera. With this function, the camera will delay the mode switch at night since the light change is temporary and unnecessary to pay attention.
RESET DEFAULT	Click to reset all camera settings to their default values.
REBOOT THE SYSTEM	Click to reboot the camera if necessary.

### 3.1 AUTO PAN SETUP

Step1: In the live view, right click to show the main menu.

Select **ADVANCED CONFIG** → **DCCS**. Then, select the channel which connects this camera, and click **SETUP** to enter the menu of camera parameters.

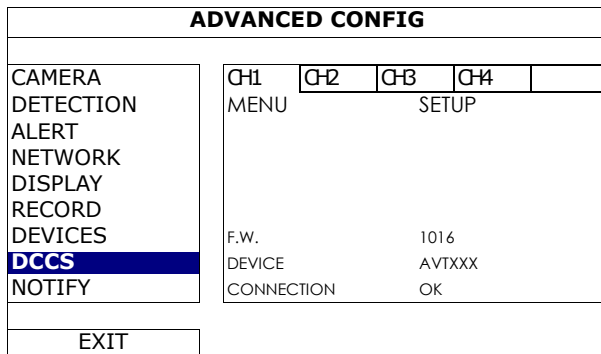

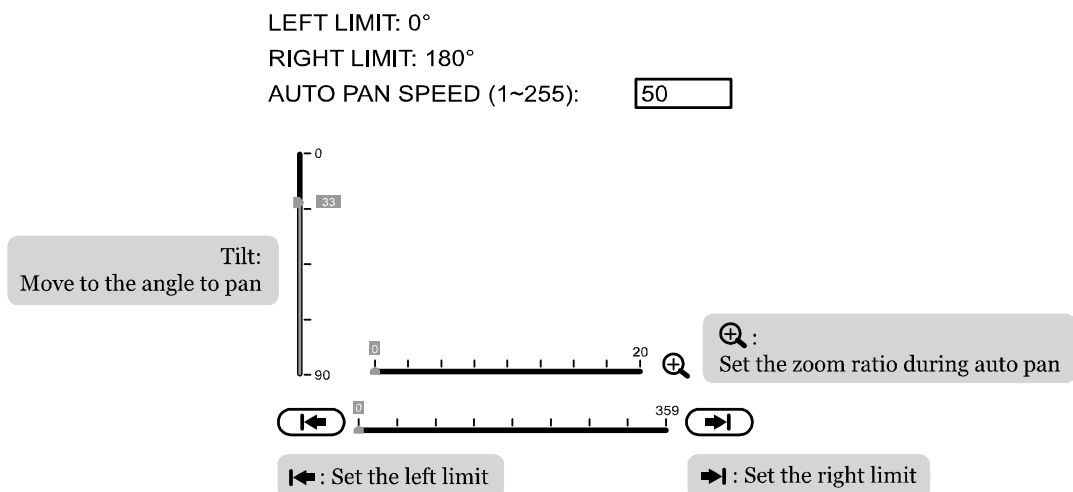

Step2: Select **CRUISE MODE**, and choose **AUTO PAN**. Then, go to **CRUISE CONFIG** to select **SETUP**.

Step3: You'll see the setting panel on the bottom left side of the screen:



Icon	Function	Description
←	Left limit	Move the slider to where you want to set as the most left side of the surveillance area, and click ← to set.
→	Right limit	Move the slider to where you want to set as the most right side of the surveillance area, and click → to set.
--	Tilt angle	Move the slider to the height you want.
+	Zoom ratio	Move the slider to confirm the zoom ratio you need for the current area.
--	Pan speed	Set the speed to pan.

Step4: Right-click to return to the live view, and click the channel with this speed dome camera connected. Then, click  on the bottom left side of the screen to show the PTZ control panel, and select  to start.

**NOTE:** To stop camera panning, click  again to escape.

### 3.2 CRUISE SETUP

Step1: In the live view, right click to show the main menu.

Select **ADVANCED CONFIG** → **DCCS**. Then, select the channel which connects this camera, and click **SETUP** to enter the menu of camera parameters.

ADVANCED CONFIG				
CAMERA DETECTION ALERT NETWORK DISPLAY RECORD DEVICES <b>DCCS</b> NOTIFY	CH1	CH2	CH3	CH4
	MENU	SETUP		
	F.W.	1016		
	DEVICE	AVTXXX		
	CONNECTION	OK		
EXIT				

Step2: Select **CRUISE MODE**, and choose **CRUISE**. Then, go to **CRUISE CONFIG** to select **SETUP**.

Step3: You'll see the setting panel on the bottom right side of the screen:

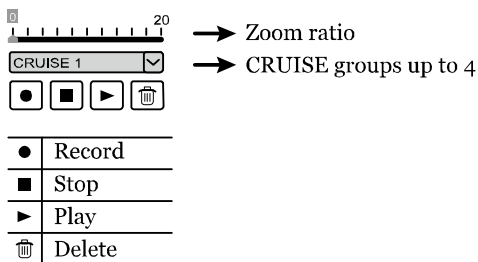

- Select the cruise group to which you want to record the route. There are 4 groups to be used.
- Move to the scene you want the cruise to be started.
- Click ● (Record). Then, drag and hold the mouse to move the camera for route planning, and scroll the mouse to zoom in / out. You'll see ● and ➤ on the screen.

---

**NOTE:** The closer these two icons, the slower the camera moving; the farther these two icons, the faster the camera moving.

---



---

**NOTE:** You have 200 seconds to customize the cruise route.

---

- Click ■ to stop route planning, and click ▶ to replay the route you just made. To discard the route you just made, click 🗑️.

Step4: Right-click to return to the live view, and click the channel with this speed dome camera connected. Then, click 🏠 on the bottom left side of the screen to show the PTZ control panel, and select 🏠 to start.

---



**NOTE:** To stop camera cruising, click 🏠 again to escape.

---

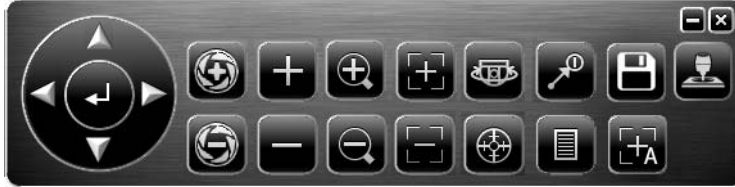

### 3.3 SEQUENCE SETUP

Step1: On the DVR live view, click the channel with this speed dome camera connected. Then, click  on the bottom left side of the screen to show the PTZ control panel.

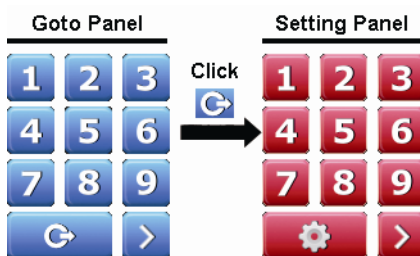

Step2: Click  to display the preset point panel, and click  to go to the setting panel.



Step3: Click  /  to move to the point you want to configure as a preset point, and click the numbering you want to appoint for this point. Then, wait till you see  (command sending) appearing and disappearing on the DVR status bar.

---

**NOTE:** Up to 256 preset points could be configured.

---

Step4: Repeat Step3 until you've added all the points you need, or click  to return to the **Goto** panel.

Step5: In the **Goto** panel, select the numbering you've appointed for the preset points to check if they're working properly.

Step6: Return to the live view, and right click to show the main menu.

Select **ADVANCED CONFIG** → **DCCS**. Then, select the channel which connects this camera, and click **SETUP** to enter the menu of camera parameters.

ADVANCED CONFIG				
CAMERA	CH1	CH2	CH3	CH4
DETECTION	MENU		SETUP	
ALERT				
NETWORK				
DISPLAY				
RECORD				
DEVICES	F.W.		1016	
<b>DCCS</b>	DEVICE		AVTXXX	
NOTIFY	CONNECTION		OK	
EXIT				





Step6: Select **CRUISE MODE**, and choose **SEQUENCE**. Then, go to **CRUISE CONFIG** to select **SETUP**.

SEQUENCE		
ACTIVE NO:	1	▼
ACTIVE TIME (MINUTES)	3	▼
No1 ▲		
No2	01 No2	DWELLTIME 0 60 PAN SPEED 0 255
<b>No3</b>	02 No4	DWELLTIME 0 60 PAN SPEED 0 255
No4	03 No5	DWELLTIME 0 60 PAN SPEED 0 255
No5 >>	04 No1	DWELLTIME 0 60 PAN SPEED 0 255
No6 <<	05 No3	DWELLTIME 0 60 PAN SPEED 0 255
No7		
No8		
No9		
No10		
No11		
No12		
No13		
No14 ▼		
EXIT		

ACTIVE TIME (MINUTES)	Select how long the area patrolling lasts in minute. The options are 2, 3 and 5.
DWELL TIME	Select the time in second after which to move to the next point. The time ranges from 3 to 60.
PAN SPEED	Select how fast to move the camera to the next point. The speed ranges from 0 to 255.

Step6: Select **EXIT**, and right click to return to the live view.

Click the channel with this speed dome camera connected. Then, click  on the bottom left side of the screen to show the PTZ control panel, and select  to start.

**NOTE:** To stop camera panning, click  again to escape.

### 3.4 CAMERA GUARD

This function is used to lock the camera to a fixed point and no pan action could be made until the lock mode is disabled. Before using this function, make sure:

- You have an iOS or android mobile device with our free app, EagleEyes, installed.
- Your TVI DVR is connected to Internet, and registered in the address book of EagleEyes.

---

**NOTE:**To know how to connect the DVR to Internet, please refer to its user manual.

---

Step1: In the live view, and right click to show the main menu.

Select **ADVANCED CONFIG** → **DCCS**. Then, select the channel which connects this camera, and click **SETUP** to enter the menu of camera parameters.

ADVANCED CONFIG					
CAMERA DETECTION ALERT NETWORK DISPLAY RECORD DEVICES <b>DCCS</b> NOTIFY	CH1	CH2	CH3	CH4	
	MENU	SETUP			
	F.W.	1016			
	DEVICE	AVTXXX			
	CONNECTION	OK			
EXIT					

Step2: Select **CAMERA GUARD**, and enable this lock function. Then, configure the timeout after which the camera will be fixed to the current point and any attempt to pan the camera to another point will be failed.

CAMERA GUARD		
GUARD LOCK	ON	
TIMEOUT (SECS)	30	▼

Step3: Go to EagleEyes on your mobile phone or tablet, and access your TVI DVR. Then, click on the channel with this camera connected, and choose any of the following methods to move the camera to the point you want:

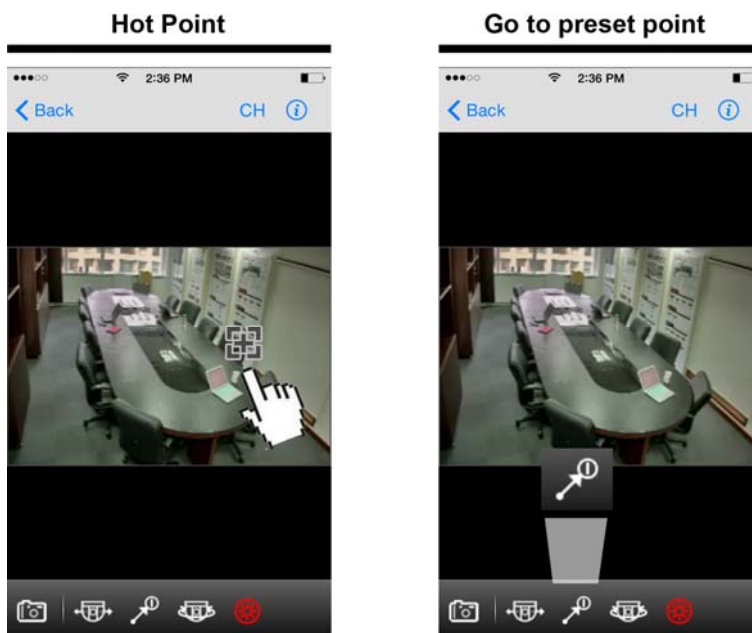

Step4: Return to the address book of EagleEyes, and enable **Guard**. The camera will fix at the point after the time specified in Step2 unless the **Guard** status is disabled.

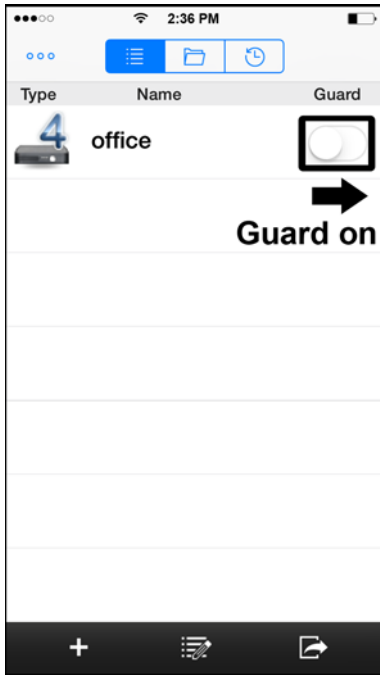

### 3.5 HOME SETUP

This function is used to configure this camera to always return to a specific point when the camera is not operated for the specified time.

Step1: In the live view, and right click to show the main menu.

Select **ADVANCED CONFIG** → **DCCS**. Then, select the channel which connects this camera, and click **SETUP** to enter the menu of camera parameters.

Step2: Select **HOME**, and enable this function.

HOME		
FUNCTION	ON	
IDLE TIME (MINUTES)	1	
TYPE	CRUISE	▼
PRESET GROUP	1	▼
PRESET NUMBER	5	▼

IDLE TIME (MINUTES)	Configure the idle time from 1 to 120 after which the camera returns to the specified point.
TYPE	Select the action to work with this function. There are four options: PRESET / AUTO PAN / SEQUENCE / CRUISE.
PRESET GROUP	Select the preset group within which has the preset point you want to configure. Then, go to PRESET NUMBER to select the preset point you want. To know how to configure preset group, please refer to the section "SEQUENCE SETUP".
PRESET NUMBER	Select the preset point you want to force the camera returning to after the specified time.

### 3.6 AUTO TRACKING SETUP

Step1: In the live view, right click to show the main menu.

Select **ADVANCED CONFIG** → **DCCS**. Then, select the channel which connects this camera, and click **SETUP** to enter the menu of camera parameters.

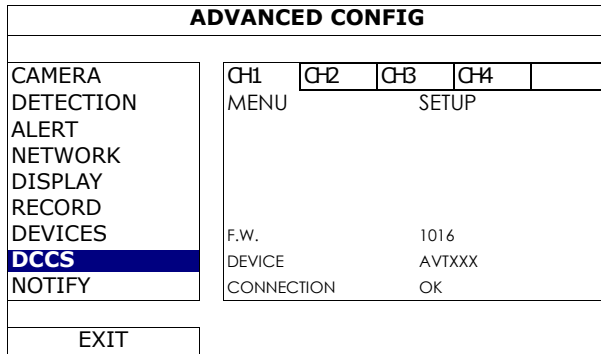

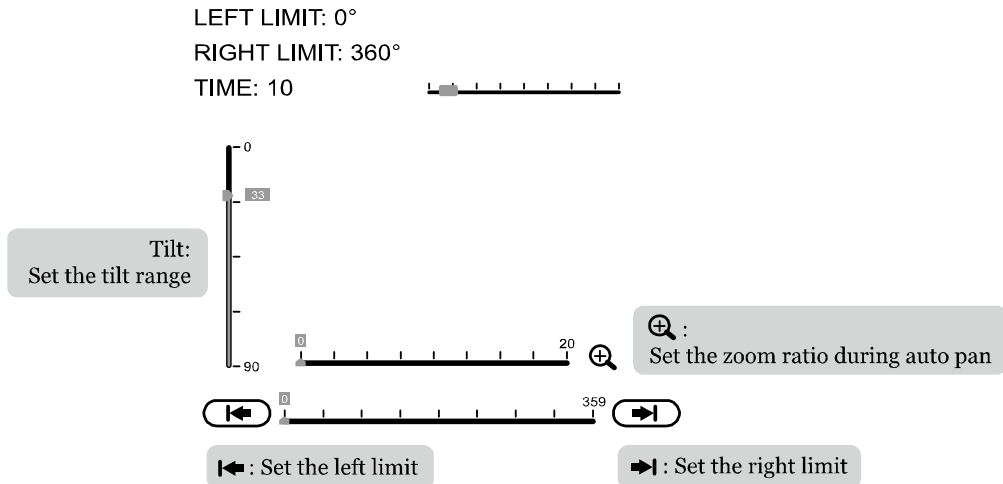

Step2: Go to **AUTO TRACKING**, and select **SETUP**.

Step3: You'll see the setting panel on the bottom left side of the screen:



Icon	Function	Description
←	Left limit	Move the slider to where you want to set as the most left side of the surveillance area, and click ← to set.
→	Right limit	Move the slider to where you want to set as the most right side of the surveillance area, and click → to set.
--	Tilt angle	Move the slider to select the tilt range of the surveillance area.
⊕	Zoom ratio	Move the slider to confirm the zoom ratio you need for the current area.
--	Time	Set pre-defined tracking timeout of the camera from 5 ~ 60 seconds, or drag directly to the right end for no time limit (INFINITE). When the locked target stops moving longer than the pre-defined tracking timeout, the camera returns to the point it originally monitors after the preset tracking timeout.

Step4: Right-click to return to the live view, and click the channel with this speed dome camera connected. Then, click  on the bottom left side of the screen to show the PTZ control panel, and select  to start.

**NOTE:** To stop camera panning, click  again to escape.









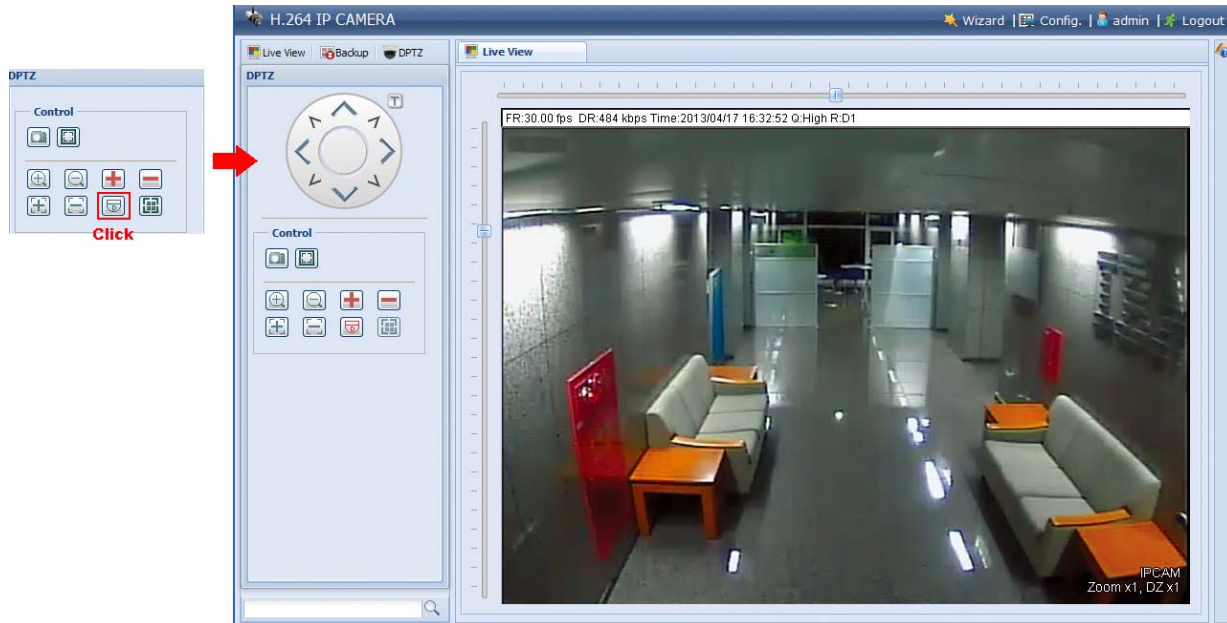







## 4. CAMERA CONFIGURATIONS – IP CAMERA

### 4.1 Digital PTZ (DPTZ) Operations

This camera series has PTZ capability, i.e. digital PTZ (hereafter called “DPTZ”), for wide area monitoring.

Click “DPTZ” on the top left corner to show the DPTZ control panel.



FUNCTION	ICON	DESCRIPTION
Moving panel	--	When  is selected, the moving control panel will be shown to move the picture after zoom-in is performed.
Take snapshots		Click to take a snapshot of the current view on a new window. Right click on the picture and re-save it to the location you want.
Normal size		The current live view size is the same as the selected resolution.
Fit to screen		The selected resolution is resized to fit into the current live view size. <i>This icon doesn't work when the selected resolution is VGA or QVGA.</i>
Scale		Click and hold the movable square on the left bottom corner of the live view to move <i>This icon appears only when the selected resolution is larger than the current live view size.</i>
Zoom in / out	 / 	Click  once to enlarge the picture by 1X, and click  once to restore the zoom ratio by 1X.
Max. zoom in / out	 / 	Click  once to enlarge the picture to the max zoom ratio by 16X, and click  once to restore the picture ratio to 1X.
Focus near / far	 / 	Click to adjust the clearness of the video images.
Focus Zone		Click to assign the point for focus adjustment. <i>This function will be disabled when DPTZ is enabled.</i>

## 4.2 Event Record Search & Playback

This camera can only save a few recordings.

**Note:** To save more recorded data, it's recommended to use this camera with the compatible NVR.

**Time Search**

Mode: Time

Start: 2011/08/31  
17 : 52 : 35

End: 2011/08/31  
18 : 49 : 27

---

**Calendar Search**

Mode: Calendar

2011

Jan Feb Mar Apr May Jun  
Jul **Aug** Sep Oct Nov Dec

August

Sun	Mon	Tue	Wed	Thu	Fri	Sat
1	2	3	4	5	6	
7	8	9	10	11	12	13
14	15	16	17	18	19	20
21	22	23	24	25	26	27
28	29	30	31			

Select Time: 00:00 - 00:00

H.264 IP CAMERA

Wizard | Config. | admin | Logout

Live View Backup DPTZ Backup

Backup

Mode: Full List



Event: EXTERNAL ALARM









Start: 2011/08/31  
17 : 52 : 35

Event	Time
	2011/08/31 17:49:56

Reload Prev. Next

**Event Icon**

 External Alarm     Motion

	Previous / Next Hour	Click to jump to the next / previous time interval in an hour, for example, 11:00 ~ 12:00 or 14:00 ~ 15:00, and start playing the earliest event video clip recorded during this whole hour.
	Fast Forward	Increase the speed for fast forward. Click to get 2X, 4X, 8X & 16X speed forward eventually.
	Fast Rewind	Increase the speed for fast rewind. Click to get 2X, 4X, 8X & 16X speed rewind eventually.
	Play	Click to play the current video clip.
	Pause	Click to pause the video playback.
	Stop	Click to stop the video playback.
	Step	In the pause mode, click to get one frame forward.
	Audio	Click to mute the playback if necessary, and click again to restore.
	Download	Click to download the current video clip to the specified path in your PC. <i>The downloaded video can only be opened by our own video player. Please go to "General" → "Maintenance" to download the video player, or get the player from the CD supplied with the sales package.</i>

## 4.3 System configuration

Click “Config.” to enter the configuration page.

**Note:** You need to be “Supervisor” to enter the system configuration page. If you’re not a “Supervisor”, please re-log into the camera with the correct user name and password.

Main Menu	Sub-Menu	Reference
Network	Network	Configure network settings.
	QoS	Limit the data flow for live streaming.
	DDNS	Enter DDNS information when the network type is PPPOE or DHCP.
	SNTP	Synchronize your camera time with the networked computer systems.
	FTP	Enter the FTP information for event notifications when “FTP” is chosen in “Trigger” → “Trigger”.
	Mail	Enter Email information for event notifications when “Email” is chosen in “Trigger” → “Trigger”.
	SMS	Enter text messaging information for SMS notifications when “SMS” is chosen in “Trigger” → “Trigger”.
	Filter	Choose to permit or block the IP address(es) which can access this camera.
	UpnP	<i>*Suitable for Windows-based operating system.</i> Allow this camera to be detected among devices within the same network area for easy and quick usage.
	Bonjour	<i>*Suitable for Apple Mac-based operating system.</i> Allow this camera to be detected among devices within the same network area for easy and quick usage.
	RTP	Set the parameters for video data transmission when you’re using multimedia other than web browsers and Video Viewer for remote access.
	SNMP	Configure SNMP to remotely manage network devices.
	IEEE 802.1X	The settings here enable the camera to access a network protected by 802.1X/EAPOL (Extensible Authentication Protocol Over LAN).
	Network Share	Assign a location in the LAN environment to save the snapshot of events when “Network Share” is chosen in “Trigger” → “Snapshot”.
	Network Failure Detection	Configure this camera to check the network connection of other device periodically, and send notifications via Email or FTP for disconnection events.
Camera	Camera	1. Set the camera title. 2. Specify the display position of the camera title. 3. Specify where the snapshot files should be saved.
	Preset	Set the preset points for the DPTZ function.
	Cruise	Set the cruise mode when the auto mode is enabled: Sequence or Auto Pan.
	Auto Tracking	Set the surveillance area for auto tracking, and the tracking timeout.
	Video	Adjust video-related settings in different video format.
	ROI	Select a specific area to reinforce the image quality of that area.
	Color	Adjust the color performance.
	Audio*	Adjust the audio volume of the microphone and speaker.
	Advanced	Adjust the camera parameters if necessary.
	Home	Configure the camera to return to the specified point or specific cruise action when the camera is not in use for a specific time.

Main Menu	Sub-Menu	Reference
VA	TA	This function should be used with the mini-guard control switch for alarm system integration. For details, please check with your distributor or installer.
	DIS	Enable this function to reduce blurring associated with the motion of a camera during exposure.
Record	Record	Configure the record function.
	Record Timer	Schedule the timer for automatic, external alarm and motion detection recording.
Storage	Memory	Check the current storage capacity and clear all recorded data when needed.
Trigger	Trigger	<ol style="list-style-type: none"> <li>1. Enable / disable motion and alarm detection.</li> <li>2. Set the motion detection area.</li> <li>3. Configure how the camera reacts for any event.</li> </ol>
	Snapshot	Schedule the camera to take snapshots periodically or at a specific time, and send to E-Mail, FTP and / or Network Share for backup. Time-lapse recording could also be configured here.
General	General	<ol style="list-style-type: none"> <li>1. Select the language of the web browser.</li> <li>2. Check the MAC address of the camera.</li> <li>3. Lock camera access after the specified time.</li> </ol>
	Time	Set daylight saving time and the current time.
	Server Log	Check the system event logs.
	Online	Check the current online user(s).
	Account	<ol style="list-style-type: none"> <li>1. Create a new user account with different access privilege.</li> <li>2. Modify or delete an existing user account.</li> </ol>
	Google Maps	Allow you to know where the camera is.
	Maintenance	<ol style="list-style-type: none"> <li>1. Check the current firmware version and upgrade your camera.</li> <li>2. Copy system configurations.</li> <li>3. Reboot the camera.</li> <li>4. Download the video player to play the recorded data.</li> </ol>



## ■ 4.3.1 Network

### Network

You can set the network configuration of the camera depending on your network type.

For details, please refer to “Advanced Network Setup” from [www.surveillance-download.com/user/z59x.swf](http://www.surveillance-download.com/user/z59x.swf).



The Network Configuration interface shows the following settings:

- IP Type:  Static IP  PPPoE  DHCP
- Server IP: 192.168.1.10
- Gateway: 192.168.1.1
- Net Mask: 255.255.255.0
- Port: 80
- DNS1: 168.95.1.1
- DNS2: 139.175.55.244
- MAC Address: 00:0E:53:20:E7:3E

Buttons: Save, Reload

### QoS

QoS, Quality of Service, is the ability to control the data flow for real-time streaming. This function is important if your network bandwidth is insufficient and you have other devices to share the network bandwidth.

Check “QoS Enable”, and set the max. upload rate from 256 to 10240 kbps.

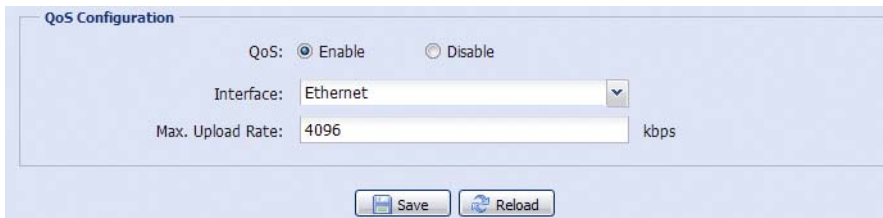

The QoS Configuration interface shows the following settings:

- QoS:  Enable  Disable
- Interface: Ethernet
- Max. Upload Rate: 4096 kbps

Buttons: Save, Reload

### DDNS

Select “On” when the selected network type in “Network” is “PPPOE” or “DHCP”.

For details, please refer to “Advanced Network Setup” from [www.surveillance-download.com/user/z59x.swf](http://www.surveillance-download.com/user/z59x.swf).

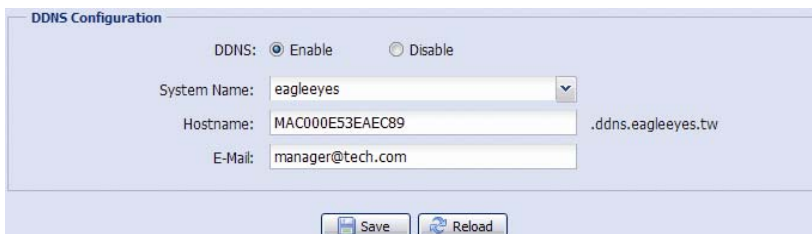

The DDNS Configuration interface shows the following settings:

- DDNS:  Enable  Disable
- System Name: eagleeyes
- Hostname: MAC000E53EAEC89 .ddns.eagleeyes.tw
- E-Mail: manager@tech.com

Buttons: Save, Reload

## Sntp

Sntp (Simple Network Time Protocol) is used to synchronize your camera time with the networked computer systems.

The screenshot shows the 'Sntp Configuration' window. It contains the following fields and controls:

- GMT: (GMT+08:00) Taipei (dropdown menu)
- NTP Server: tock.stdtime.gov.tw (text input)
- Sync. Period: Daily (dropdown menu)
- Server Time: 2011-08-30 20:34:42 (text display)
- Buttons: Sync., Save, Reload

Function	Description
GMT	Once users choose the time zone, the camera will adjust the local area time of the system automatically.
NTP Server	Simply use the default Sntp server (For example, tock.stdtime.gov.tw) or change to another server with which users are familiar.
Sync. Period	Select "Daily" to synchronize the camera time with the network time every day or "None" to turn off this function.
Sync	Click and the camera will synchronize the time with the network time.

## Ftp

Enter the detailed ftp information and click "Save" to confirm. The information you set here will be applied when "ftp" is selected in "Trigger" → "Trigger".

The screenshot shows the 'Ftp Configuration' window. It contains the following fields and controls:

- Username: manager (text input)
- Password: •••••• (password input)
- Server: 211.75.85.33 (text input)
- Port: 21 (text input)
- Directory: upload (text input)
- Mode: Passive (dropdown menu)
- Buttons: Save, Test, Reload

## Mail

Enter the detailed e-mail information and click "Save" to confirm. The information you set here will be applied when "Email" is selected in "Trigger" → "Trigger".

The screenshot shows two parts of the web interface:

**SMTP Configuration**

- SMTP Server: smtp.gmail.com (text input)
- Port: 465 (text input)
- Mail From: office\_manager@gmail.com (text input)
- Use SSL Encryption:  Yes  No
- Verify Password:  Yes  No
- Username: manager (text input)
- Password: •••••• (password input)
- Subject: Trigger Occur! (text input)
- Buttons: Save, Test, Reload

**E-Mail Address List**

- E-Mail Address: [input field] Add Edit Delete
- Receiver Name: boss
- E-Mail Address: boss@tech.com

Function	Description
SMTP Server	Enter the SMTP server address provided from your e-mail system supplier.
Port	Enter the port number provided from your e-mail system supplier. If this column is left blank, the e-mail server will use port 25 to send e-mails.
Mail From	Enter the name of the sender.
SSL Encryption	Select "Yes" if your e-mail server is using SSL encryption to protect your e-mail content from unauthorized access.
Verify Password	Some mail servers are required to verify the password. Please enter the "user name" and "password".
Subject	Enter the subject for the E-Mail.
E-Mail Address List	Add the e-mail address(s) of the assigned recipient(s).
Test	When all information is entered, click "Test Mail" to try if the receipt.

## SMS

**Note:** Before using this function, you need to apply an account and get an API ID from the mobile messaging company, such as Clickatell and EVERY8D.  
For details, please refer to "API ID APPLICATION FOR SMS MESSAGING" at page 48.

Enter the detailed information needed for text messaging, and click "Save" to confirm. The information you set here will be applied when "SMS" is selected in "General" → "Trigger".

The screenshot shows the 'SMS Configuration' interface. It contains the following fields and controls:

- System:** A dropdown menu with 'clickatell' selected.
- Username:** A text input field containing 'tech'.
- Password:** A text input field with masked characters '\*\*\*\*\*'.
- API ID:** A text input field containing '3281378'.
- Recipient:** A text input field containing '+886912665475' with a small flag icon to the left.
- Transfer Interval:** A dropdown menu with '15' selected, followed by 'Minute(s)' and a 'Reset Counter' button.
- Message:** A text area containing '[192.168.1.10] unauthorized access!' and a checked checkbox for 'Include Hostname or IP'.
- Buttons:** 'Save', 'Test', and 'Reload' buttons at the bottom.

Function	Description
System	The text messaging service provider is Clickatell.
User name / Password	Enter the account user name and password you created in Clickatell.
API ID	Enter the API ID you applied from Clickatell.
Recipient	Click "Add" to enter the phone number, including the country code, to receive the text message. Five sets of phone numbers are allowed.
Transfer Interval	Set the interval time in minutes between two-message sending. The options are 0, 15, 30 & 60.
Reset Counter	Click to restart the text messaging, and the SMS will be sent after the specified time interval since you click this button.
Message	Enter the text content (up to 70 characters) you want to send with the text message.

Function	Description
Test	To know whether your SMS setting is correct, click this button to immediately send a SMS to your phone. Note: This testing is not free and you will be charged for SMS sending base on your local rate.

## Filter

Choose to permit or block the IP address(es) which can access this camera, and click “Save” to confirm.

The screenshot shows the 'Filter Configuration' web page. At the top, there are three input fields: 'Error Count' with the value '3', 'Error Lock Time' with the value '1' and the unit 'Minute(s)', and 'Echo Request' with radio buttons for 'Non-Block' (selected) and 'Block'. Below this is the 'IP/MAC Filter Configuration' section, which includes 'IP/MAC Filter' with radio buttons for 'Enable' (selected) and 'Disable', and 'IP/MAC Filter Policy' with radio buttons for 'Allow' (selected) and 'Deny'. The 'IP/MAC Filter Rules' section features a table with one rule: '192.168.1.122'. There are 'Add' and 'Delete' buttons next to the rule input field. At the bottom of the form, there are 'Save' and 'Reload' buttons.

Function	Description
<b>Filter Configuration</b>	
Error Count	Set the maximum count for login failure. When the maximum count is reached, the IP address trying to access the camera will be locked.
Error Lock Time	Set the lock time in minutes when the maximum count of error login for an IP address is reached.
Echo Request	Select “Non-Block” to allow other users to use the ping command to detect the IP address of your camera, or “Block” to deny the ping command request.
<b>IP/MAC Filter Configuration</b>	
IP/MAC Filter	Choose to enable or disable the filter function.
IP/MAC Filter Policy	If “Enable” is selected, choose whether you want to permit (Allow) or block (Deny) the IP address list below.
<b>IP/MAC Filter Rules</b>	
Rule	<ul style="list-style-type: none"> <li>To add an item to the IP address list, key in the IP address in “Rule”, and click “Add”.</li> <li>To remove an existing item in the IP address list, click the item you want to remove, and click “Delete”.</li> </ul>

## **UPnP / Bonjour**

“UPnP” stands for “Universal Plug and Play”, which allows devices to connect seamlessly in the home and corporate environments and simplify installation of computer components, and is only suitable for Microsoft Windows-based operating system.

“Bonjour” functions the same as “UPnP”, but it’s only suitable for Apple Mac-based operating system.

### ➤ **UPnP**



The screenshot shows the "UPnP Configuration" window. It has a title bar "UPnP Configuration". Below the title bar, there are two radio buttons: "UPnP:  Enable  Disable". Below that is a text input field labeled "Friendly Name:" containing the text "IP CAMERA (Fixed) 000E531574E3". At the bottom of the window, there are two buttons: "Save" and "Reload".

### ➤ **Bonjour**

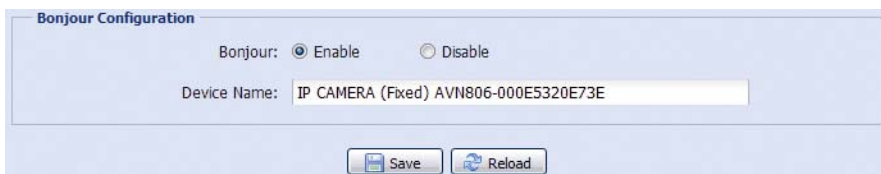

The screenshot shows the "Bonjour Configuration" window. It has a title bar "Bonjour Configuration". Below the title bar, there are two radio buttons: "Bonjour:  Enable  Disable". Below that is a text input field labeled "Device Name:" containing the text "IP CAMERA (Fixed) AVN806-000E5320E73E". At the bottom of the window, there are two buttons: "Save" and "Reload".

Check “Enable” to allow the camera to be detected among devices within the same network area, and set the identification name of the camera in “Friendly name”.

When this function is activated, the other PC within the same domain as this camera will be able to search this camera in:

- “Network Neighbor” with the identification name set in “Friendly name” for Windows-based PC, or
- “” (finder) or “Bookmark” with the identification name set in “Device Name” for Mac-based PC.

Double-click it to quickly open the web browser for camera access.

## **Port Mapping (Available only in UPnP)**

This function can eliminate the need to additionally access the router for port forwarding.

For details, please refer to “Advanced Network Setup” from [www.surveillance-download.com/user/z59x.swf](http://www.surveillance-download.com/user/z59x.swf).

---

**Note:** Before using this function, make sure your router supports UPnP, and this function is enabled. If not, please access your router additionally for port forwarding.

---

When “Port Mapping” is set to “Enable”, the system will automatically assign an IP address or port number for you if no IP address or port number is entered.

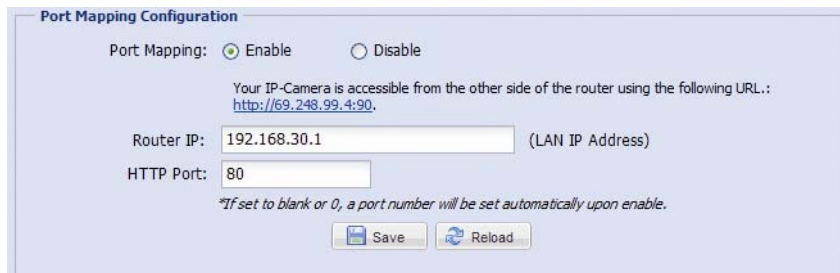

The screenshot shows the "Port Mapping Configuration" window. It has a title bar "Port Mapping Configuration". Below the title bar, there are two radio buttons: "Port Mapping:  Enable  Disable". Below that is a text input field labeled "Router IP:" containing the text "192.168.30.1" and "(LAN IP Address)". Below that is a text input field labeled "HTTP Port:" containing the text "80". Below the "HTTP Port:" field is a small italicized note: "\*If set to blank or 0, a port number will be set automatically upon enable.". At the bottom of the window, there are two buttons: "Save" and "Reload".

---

**Note:** When the configurations are saved successfully, you’ll see a message indicating the IP address and port number assigned to this camera.

---

## RTP

The Real-time Transport Protocol (RTP) is an Internet protocol standard to manage the real-time transmission of multimedia, such as VLC player.

The media player you want to use for remote access must support RTP transmission for this function to work normally.

---

**Note:** When you're about to end the remote access, please press the stop button on your media player first, and then close the program. This is to ensure the server receives the stop command, and also help to protect the server from redundant data transmission.

---

**Port Range**

Start Port: 50000  
End Port: 60000

**Video**

Profile	Address	Port	Time to Live (TTL)
1	239.101.101.101	9000	15
2	239.101.101.102	9000	15
3	239.101.101.103	9000	15
4	239.101.101.104	9000	15

**Audio**

Profile	Address	Port	Time to Live (TTL)
1	239.101.102.101	9000	15
2	239.101.102.102	9000	15
3	239.101.102.103	9000	15
4	239.101.102.104	9000	15

Save Reload

Function	Description
<b>Port Range</b>	The port range used by RTP is limited, and preserving 100 ports between the start port and end port is necessary.
Start Port	The range of the start port is 1024 ~ 65434.
End Port	The range of the end port is 1124 ~ 65534.
<b>Video</b>	
Address and port for video transmission	Set a specific address and port for multicast of profile 1 ~ 4. The range of the address is limited between 224.0.0.1 ~ 239.255.255.255. The port for multicast must be an even number.
<b>Audio</b>	
Address and port for audio transmission	Set a specific address and port for multicast of audio. The range of the address is limited between 224.0.0.1 ~ 239.255.255.255. The port for multicast must be an even number.

## IEEE 802.1X

The settings here enable the camera to access a network protected by 802.1X/EAPOL (Extensible Authentication Protocol Over LAN).

---

**Note:** For authentication to work properly, it's important to synchronize the time in the camera with an NTP server.

---

Before using this function, make sure:

- The switch and RADIUS server you have in the LAN environment supports IEEE 802.1X, and IEEE 802.1X settings are enabled.
- You've applied a digital certificate from a Certificate Authority which can be validated by a RADIUS server, and the identity and password used.

Then, follow the steps below:

Step1: Connect this camera to a PC or laptop directly, and go to its login page to log in.

---

**Note:** To know how to connect the camera to a PC or laptop directly, please check "4 Modem / Hub + Modem" in "[ADVANCED NETWORK SETUP](#)".

---

Step2: Log into the camera, and go to "Config" → "Network" → "IEEE 802.1X". Enable this function, and select the EAP method you want to use.

---

**Note:** This camera supports "EAP-PEAP", "EAP-TLS" and "EAP-TTLS".

---

Step3: Enter the identity and password you get from the Certificate Authority, and select the EAPOL version used in your switch.

Step4: Upload the certificate(s) issued by the Certificate Authority, and save.

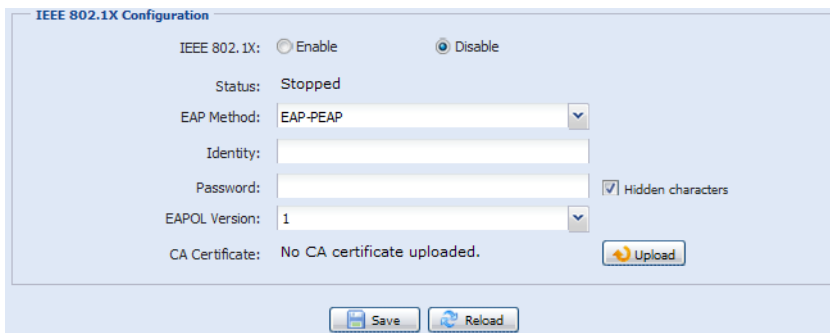

Step5: Disconnect the camera from your PC or laptop, and connect it to the switch in the LAN environment you want to use IEEE 802.1x, and the camera will start the authentication later.

## **Network Share**

This function is used to assign a location in the LAN environment to save the snapshot of events.

---

**Note:** This function is available only for Windows operating systems.

---

The information you set here will be applied when "Network Share" is selected in "Trigger" → "Snapshot" → "Storage Mode".



To use this function, make sure:

- A PC is installed in the same LAN environment as this camera, and you know the IP address of the PC.
- A PC account is created as "Administrator" with a user name and password.
- A folder in the PC is opened as shared to the user account you assigned.

---

**Note:** Please check "PREREQUISITES FOR NETWORK SHARE" at page 50 for more details.

---

Enable this function, and enter the address of the PC, the folder being shared, and the user name and password to access the PC. If the information is all correct, you'll see a check in the "Status" column, and you're ready to go to "Trigger" → "Snapshot" for further configurations.

## Network Failure Detection

Configure this camera to check the network connection of other device periodically, and send notifications via Email or FTP for disconnection events.

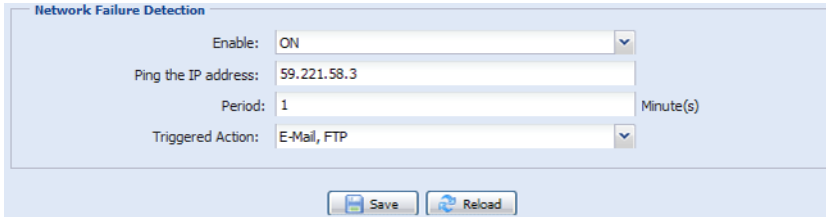

The screenshot shows the 'Network Failure Detection' configuration interface. It includes the following fields:

- Enable: ON (dropdown menu)
- Ping the IP address: 59.221.58.3 (text input)
- Period: 1 (text input) Minute(s)
- Triggered Action: E-Mail, FTP (dropdown menu)

At the bottom, there are 'Save' and 'Reload' buttons.

## 4.3.2 Camera

### Camera

In this menu, you can set the camera title, OSD display, and location to save snapshots.

---

**Note:** The actual functions shown depend on the model you have.

---

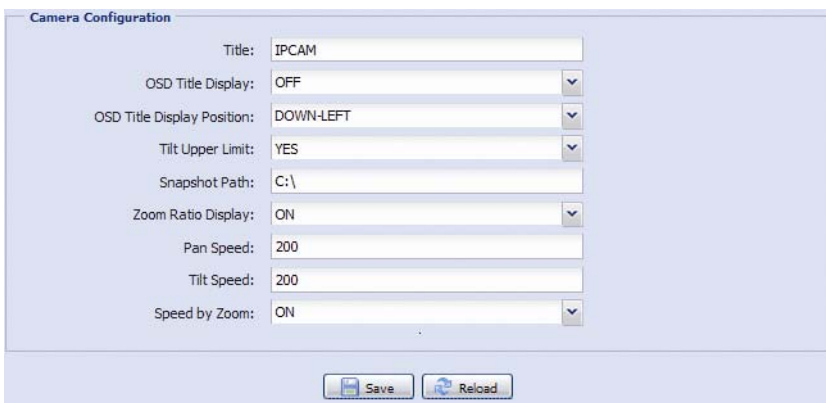

The screenshot shows the 'Camera Configuration' interface with the following settings:

- Title: IPCAM
- OSD Title Display: OFF (dropdown menu)
- OSD Title Display Position: DOWN-LEFT (dropdown menu)
- Tilt Upper Limit: YES (dropdown menu)
- Snapshot Path: C:\ (text input)
- Zoom Ratio Display: ON (dropdown menu)
- Pan Speed: 200 (text input)
- Tilt Speed: 200 (text input)
- Speed by Zoom: ON (dropdown menu)

At the bottom, there are 'Save' and 'Reload' buttons.

### Preset

---

**Note:** Before using this function, make sure the DPTZ function is enabled.

---

You can set new preset points (up to 16) or check existing points here.

#### How to set a new preset point

Step1: Click to where you want to see, and you'll get a 5x zoom-in image. To slightly zoom out, draw a square from the bottom right to top left, and you'll get a 3x image. Draw the square again and you'll return to the original size.

Step2: In "Current Position", give a name to this point, and click "Add".

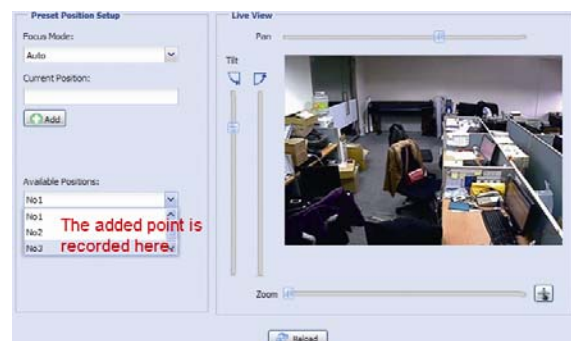
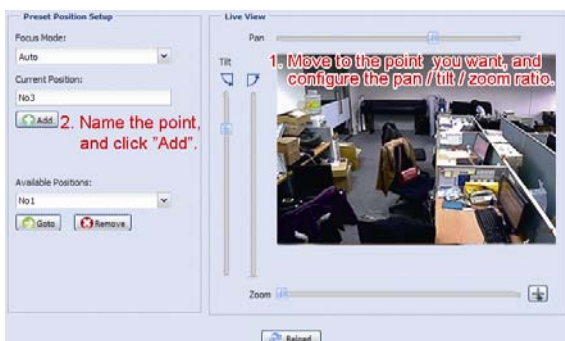



### How to check an existing preset point

In “Available Positions”, select the name of the point you want to check from the drop-down list, and click “Goto”.

You will see the camera view on the right side moving to the point it’s recorded.

### How to delete an existing preset point

In “Available Positions”, select the name of the point you want to check from the drop-down list, and click “Remove”.

## **Cruise**

---

**Note:** Before using this function, make sure you have finished setting several preset points.

---

Here defines how the auto mode of the camera is going to work when **AUTO** is selected: Sequence, Auto Pan or Cruise.

### Cruise

When “Cruise” is selected here and **AUTO** is clicked on the live view page, the camera will start cruising.

This function is used to record the monitoring route you want up to 200 seconds. Up to four cruise routes could be saved in this menu. You could also preview and remove the routes as needed.

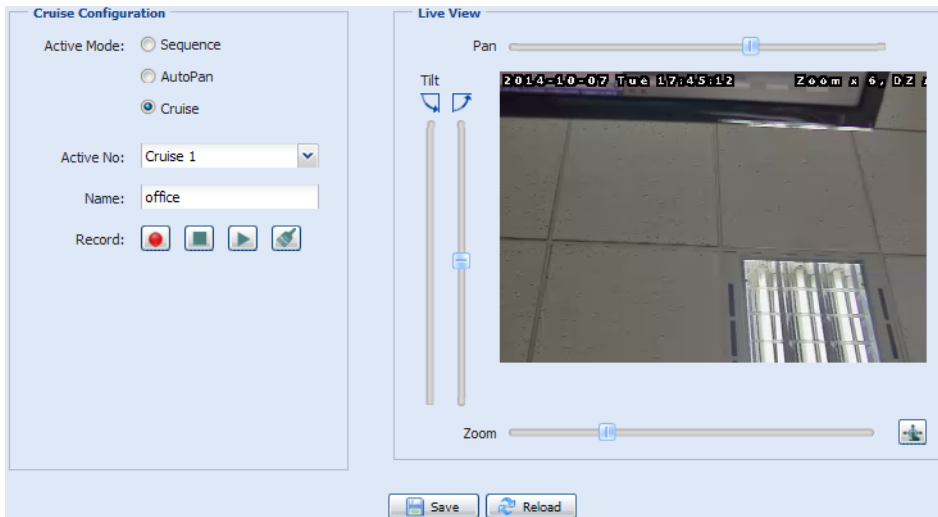

### Auto Pan

When “Auto Pan” is selected here and **AUTO** is clicked on the live view page, the camera will start panning.

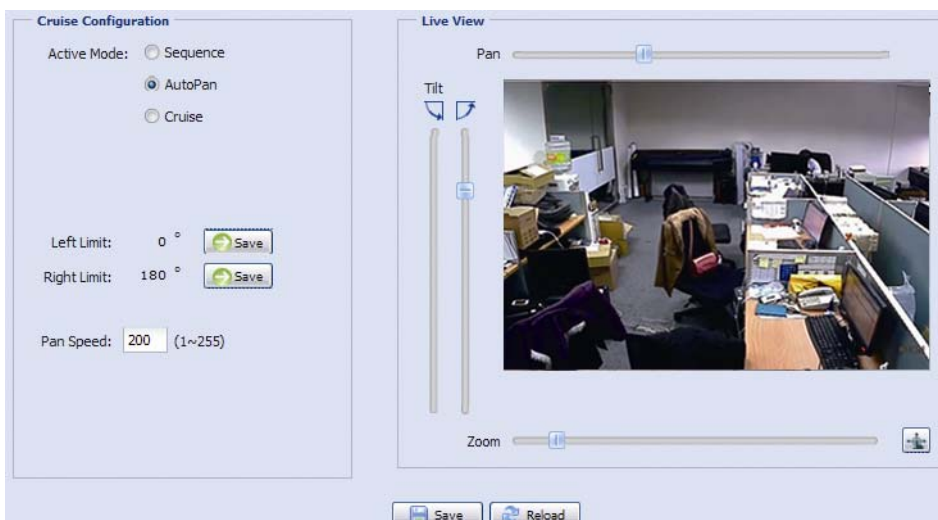

## Sequence

When “Sequence” is selected here and  is clicked on the live view page, the camera will start patrolling each preset point defined in “Sequence”.

Step1: Click “Add” to choose a preset point from the drop-down list, and select the duration to stay at this point from 1 ~ 60 minutes.

Then, click “Save” to confirm.

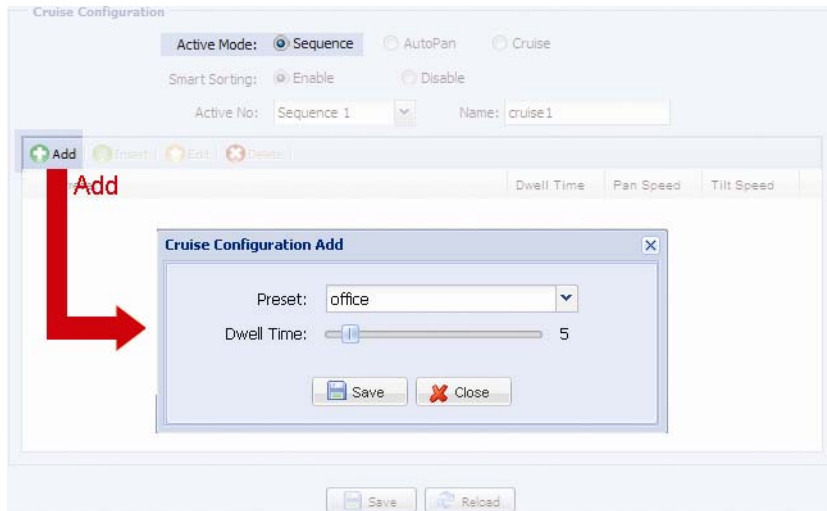

Step2: Click “Add” again to add more preset points. When all the points are added, click “Save” to confirm.

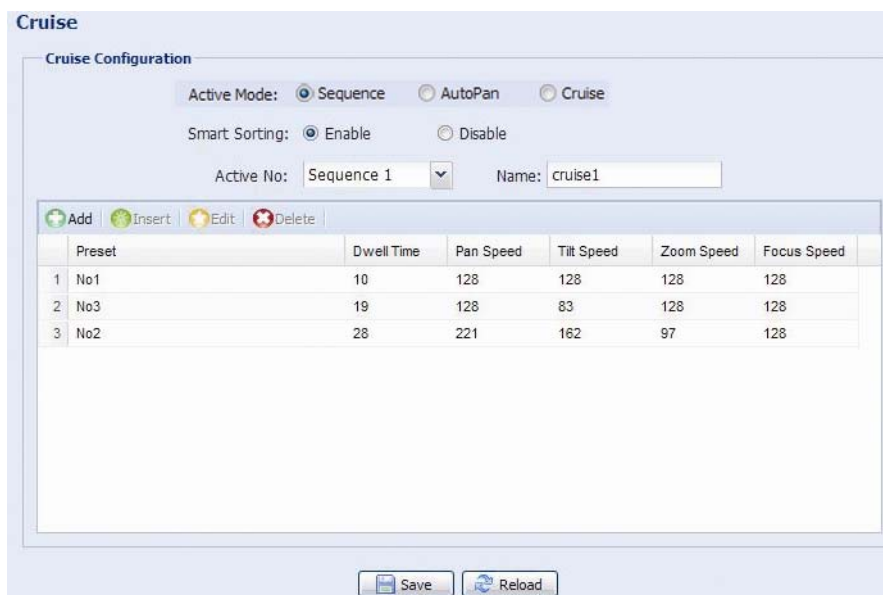

## Auto Tracking

Set the surveillance area for auto tracking, and the tracking timeout.

When the locked target is out of the pre-defined surveillance area or stops moving for a pre-defined period of time, the camera returns to the point it originally monitors.

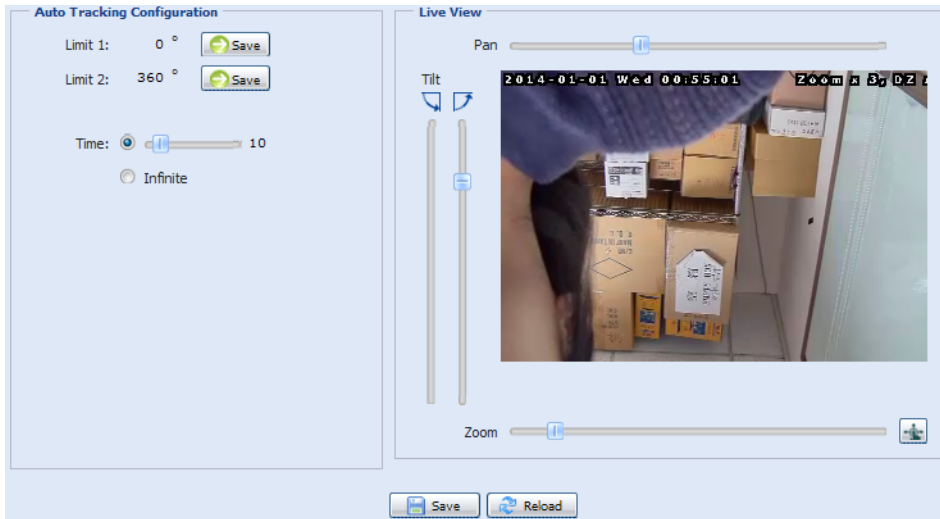

Item	Description
Limit 1	When the locked target moves out of the surveillance area, the camera returns to the point it originally monitors after the preset tracking timeout. By clicking and dragging the slider, set the left end of the surveillance area from 0° ~ 360°.
Limit 2	When the locked target moves out of the surveillance area, the camera returns to the point it originally monitors after the preset tracking timeout. By clicking and dragging the slider, set the right end of the surveillance area from 0° ~ 360°.
Time	When the locked target stops moving longer than the pre-defined tracking timeout, the camera returns to the point it originally monitors after the preset tracking timeout. By clicking and dragging the slider, set pre-defined tracking timeout of the camera from 5 ~ 60 seconds, or you can choose to have no time limit (Infinite).

## Video

Adjust video-related settings in different video format.

- “Quality” is related to image clearness.
- “FPS” is related to the fluency of the video. The more the FPS, the more fluent the video.
- “Max Bit Rate” is the maximum limitation of data transmission in the selected image format and resolution.

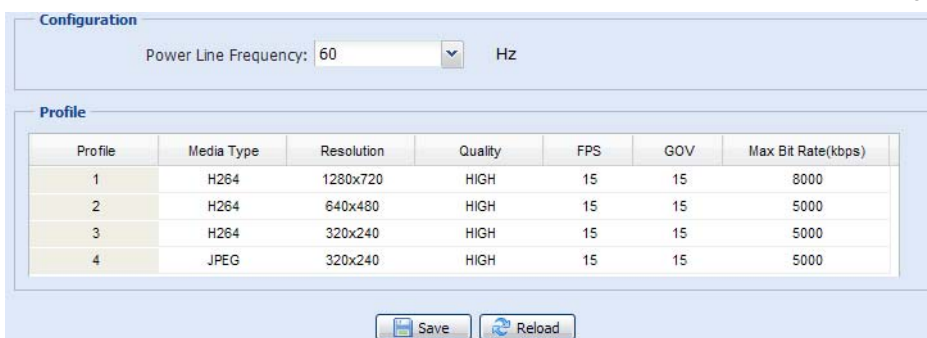

## ROI

ROI, Region of Interest, is used to reinforce the image quality of the selected area(s). Users could specify two areas in the camera view.

**Region of Interest**

Region	Enable	Quality
1	ON	10
2	OFF	7

Edit | Reload

**Live View**

**Edit**

Enable: ON

Quality: 10

Save | Cancel

## Color

Adjust the color performance from Brightness, Contrast, Hue and Saturation. Click and drag the slider to preview the color change on the right side of this page and adjust the image color.

To restore the default values, click "Back to Default".

**Color Configuration**

Brightness: 50

Contrast: 55

Hue: 50

Saturation: 65

**Live View**

Back to Default | Reload

## Audio

Drag the slider to adjust the volume of the microphone and speaker.

**Audio Volume Configuration**

Input(Mic.): 5  Mute

Output(Speaker): 5  Mute

Back to Default | Reload

## Advanced

Adjust the camera parameters if necessary.

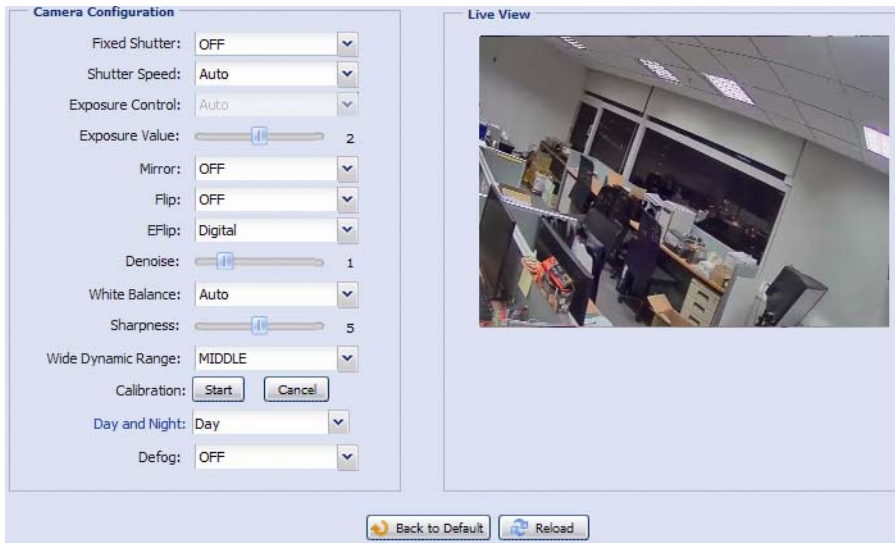

Item	Description
Fixed Shutter	Shutter Speed is a function that can adjust the duration of the electronic shutter to produce optimum image quality. Select the shutter speed suitable for your environment.
Slow Shutter Speed	Select the slow shutter speed suitable for your environment. A slower shutter speed in dark conditions will help to produce a brighter image, but will produce fewer frames per second, which may cause images to get blurry during motion.
Exposure Control	This function is used to synchronize the shutter time to the fluorescent light to suppress image flickering.
Exposure Value	Drag the slider to adjust the exposure level from 0 ~ 4.
Mirror	Select "ON" to rotate the images horizontally based on your installation situation when necessary.
Flip	Select "ON" to rotate the image 180° when necessary.
EFlip	This function is used to keep the image upright always after pan / tilt movement. The options are: OFF / Digital (default) / Mechanical
Denoise	Click and drag the slider to adjust the level from 0 ~ 10 to decrease the noise shown in the dark environment.
IR Control	Select "Auto" to automatically enable IR LEDs at night or in the dark environment, "On" to always enable IR LEDs, or "OFF" to disable this function.
IR Extend Time	Set the delay time from 1 ~ 60 in second after which the day and night switch is made, or select 0 to disable this function.  This is used for the environment where the light condition may change suddenly and usually last for a short time, for example, the entrance of a parking lot. It may cause the day & night mode switching constantly and damage the camera.  With this function, the camera will delay the mode switch at night since the light change is temporary and unnecessary to pay attention.
IR Turn On Level	Select the level for IR light to activate. 0 means off.
White Balance	Process the current image to retain color balance over a color temperature range.
Sharpness	Sharpness enhances the clarity of image detail by adjusting the aperture and sharpening the edges in the pictures.  Hold and drag the slider to adjust the level of sharpness. The higher the value, the sharper the image.
Wide Dynamic Range	Wide Dynamic Range (WDR) is used when users need to increase image recognizability in overexposure and dark areas.  The options are: LOW / MIDDLE / HIGH / OFF

Item	Description
IRIS	IRIS is used to adjust the amount of light reaching the image sensor for best image results. When the shutter speed is selected to a certain value, the iris mode is switched to "AI". Please adjust the image brightness here when necessary.
Day and Night	This function is used to configure the day and night mode: <ul style="list-style-type: none"> <li>Day - Always stay in the day mode (color).</li> <li>Night - Always stay in the night mode (B/W).</li> <li>Image - Automatically switch based on the light condition of the image captured</li> <li>Time – Select this option, and click "Day and Night" in blue to enable and set a schedule to enable day and night mode. The selected time (yellow) will be in the day mode, and the unselected time will be in the night mode.</li> <li>Digital Input N.O. – Normally stay in the day mode, and switch to the night mode when the alarm is triggered.</li> <li>Digital Input N.C. – Normally stay in the night mode, and switch to the day mode the when alarm in triggered.</li> </ul>
Defog	Select "ON" to enable the defog function in poor weather conditions such as fog, smog or smoke. The captured image can be improved.
Auto Focus Calibration	Select "Start" to start calibrate focus automatically.

## Home

Configure the camera to return to the specified point or specific cruise action when the camera is not in use for a specific time.

## 4.3.3 VA

### TA

TA, tampering alarm, should be used with the mini-guard control switch for alarm system integration. For more details, please check with your distributor or installer.

### DIS

DIS, digital image stabilization, is used to reduce blurring associated with the motion of a camera during exposure.

## ■ 4.3.4 Record

### **Record**

In “Record Configuration”, you can:

- Enable or disable the alarm record function. When “Enable” is set to “No”, the alarm record function is disabled even if you enable it in other configuration pages.
- Select if the data should be overwritten when the memory storage is full.
- Enable or disable the audio record function.
- Select the video resolution for event recording.

---

---

**Note:** The higher resolution you choose, the more accuracy and higher image quality the recording will be, but the faster the memory storage is consumed and become full

---

---

The screenshot shows the 'Record Configuration' web interface. It features four radio button options: 'Enable' (Yes selected), 'Overwrite' (Yes selected), 'Record Audio' (Yes selected), and 'Record Resolution' (VGA selected from a dropdown menu). At the bottom, there are 'Save' and 'Reload' buttons.

### **Record Timer**

To schedule the timer for automatic, alarm and motion recording, enable it, and select the day and time for recording.

---

---

**Note:** The timer must be enabled for the record function to work properly.

---

---

---

---

**Note:** The selected time will be yellow-colored.

---

---

The screenshot shows the 'Record Timer' web interface. It has tabs for 'Timer', 'External Alarm', and 'Motion'. The 'Motion' tab is active. At the top, 'Enable' is set to 'Yes'. Below is a 24-hour grid with days of the week (SUN to SAT) on the y-axis and hours (0 to 23) on the x-axis. A yellow shaded area covers the hours from 8 to 20 for Monday through Friday. 'Save' and 'Reload' buttons are at the bottom.



## ■ 4.3.5 Storage

### **Memory**

In “Memory”, you can check the remaining capacity for recording, or clear all recorded data saved if needed.

---

**Note:** The recorded data will be removed also when you reset or reboot this camera.

---

You can only record a limited number of recordings.

---

**Note:** To save more recorded data, it’s recommended to use this camera with the compatible NVR.

---

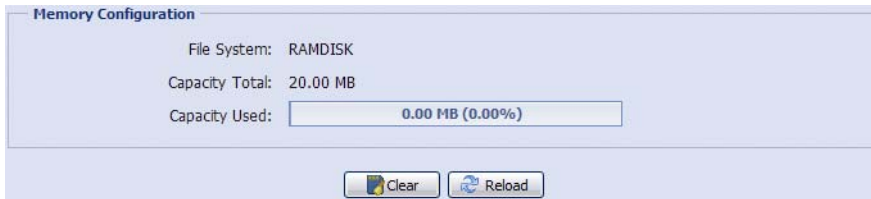

The screenshot shows the 'Memory Configuration' window. It displays the following information:

- File System: RAMDISK
- Capacity Total: 20.00 MB
- Capacity Used: 0.00 MB (0.00%)

At the bottom, there are two buttons: 'Clear' and 'Reload'.

## ■ 4.3.6 Trigger

### **Trigger**

You can configure how this camera reacts when there’s an alarm or a motion event.

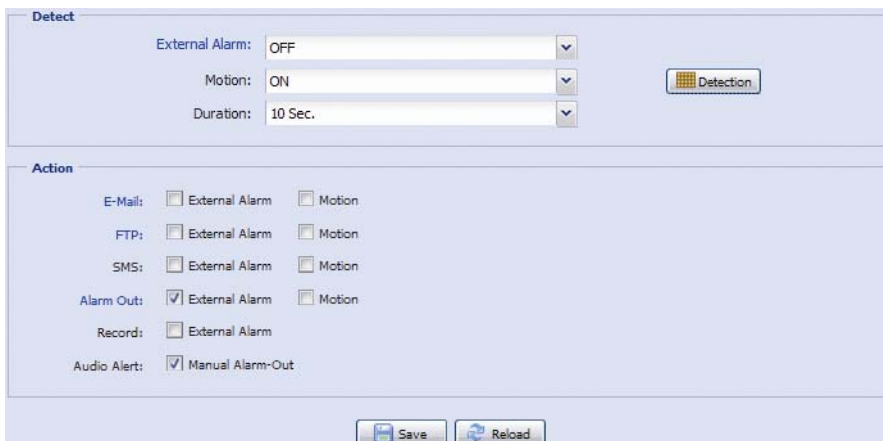

The screenshot shows the 'Trigger' configuration window, divided into 'Detect' and 'Action' sections.

**Detect Section:**

- External Alarm: OFF (dropdown menu)
- Motion: ON (dropdown menu)
- Duration: 10 Sec. (dropdown menu)
- Detection button (grid icon)

**Action Section:**

- E-Mail:  External Alarm  Motion
- FTP:  External Alarm  Motion
- SMS:  External Alarm  Motion
- Alarm Out:  External Alarm  Motion
- Record:  External Alarm
- Audio Alert:  Manual Alarm-Out

At the bottom, there are two buttons: 'Save' and 'Reload'.

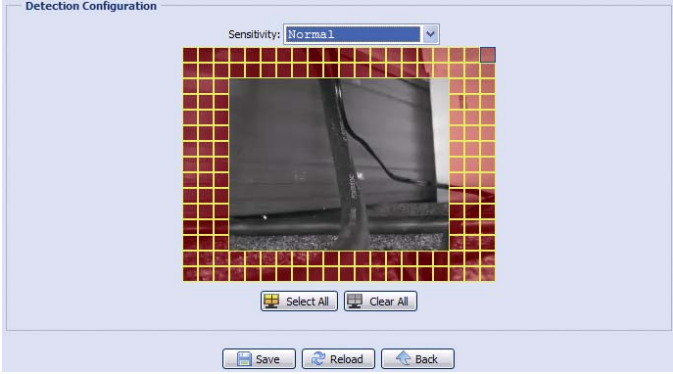

## Detect

Item	Description
External Alarm	Enable or disable detection from external alarm-in device, and click the title "External Alarm" (in blue) to set "N.O." or "N.C." depending on the configuration of your alarm-in device.
Motion	<p>Enable or disable motion detection.</p> <p><i>Motion detection is not supported when the stream format is Motion JPEG.</i></p> <p>When "ON" is selected, click "Detection" to enter the motion detection area setting page as follows:</p>  <p><b>Sensitivity:</b></p> <p>Set the detection sensitivity from the drop-down list: High, Normal or Low.</p> <p><b>Area Setting:</b></p> <p>Set the motion detection area by selecting the area grids with your mouse. Pink grids represent the area that is not being detected while the transparent grids are the area under detection. You can set multiple areas under detection.</p> <p>Click "Clear All" to set the whole area undetected.</p> <p>Click "Select All" to set the whole area under detection.</p>
Duration	Set the duration time for trigger recording (5 / 10 / 20 / 40 seconds).

## Action

Here defines how the camera delivers alerts to you for any event.

Item	Description
E-Mail	<p>Select the event type you want to receive E-mail notifications when it occurs.</p> <p>Then, click the title "E-Mail" (in blue) to configure the media type or profile, file format (AVC / AVI) and record time (1 ~ 5 seconds) for the event video clip. If you don't want event video clips to be attached in the email, select "No" in "Email Attachment".</p> <p>The camera will send an Email to the E-mail address(s) you assigned in "Network" → "Mail" once the selected event type occurs.</p>
FTP	<p>Select the event type you want to receive FTP notifications when it occurs.</p> <p>Then, click the title "FTP" (in blue) to configure the media type (H264 / JPEG / MPEG4), file format (AVC / AVI), and record time (1 ~ 5 seconds) for the event video clip.</p> <p>The camera will upload the captured video clip to the FTP site you assigned in "Network" → "FTP" once the selected event type occurs.</p>
SMS	<p>Select the event type you want to receive text message when it occurs.</p> <p>The camera will send a text message to the phone number you assigned in "Network" → "SMS" once the selected event type occurs.</p>
Alarm Out	<p>Select the event type you want to trigger the alarm-out device to work when it occurs.</p> <p>Then, click the title "Alarm Out" (in blue) to configure the trigger rule (LOW / HIGH).</p>
Record	Select the event type you want to enable event recording when it occurs.
Audio Alert	Select the event type you want to enable audio alert when it occurs.

## **Snapshot**

Enable this function to schedule the camera to take snapshots periodically or at a specific time, and send the snapshots to E-Mail, FTP, and / or Network Share for backup.

---

**Note:** Before using E-Mail, FTP and Network Share, make sure the related configurations are done in "Network" → "Mail", "Network" → "FTP", and "Network" → "Network Share".

---

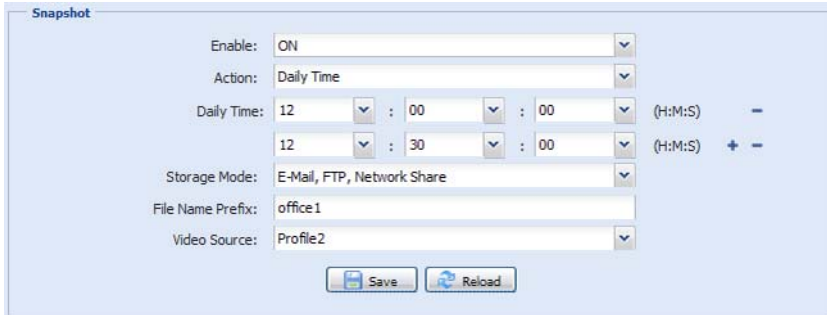

The screenshot shows the "Snapshot" configuration window. It includes the following fields and controls:

- Enable: ON (dropdown menu)
- Action: Daily Time (dropdown menu)
- Daily Time: 12 : 00 : 00 (H:M:S) with a minus sign (-)
- Daily Time: 12 : 30 : 00 (H:M:S) with plus and minus signs (+ -)
- Storage Mode: E-Mail, FTP, Network Share (dropdown menu)
- File Name Prefix: office1 (text input)
- Video Source: Profile2 (dropdown menu)
- Buttons: Save and Reload

## **Time-lapse Recording**

This function allows users to create time-lapse recording by combining snapshots together.

---

**Note:** To use this function, make sure "Network Share" is configured well in "Network" → "Network Share". For details, please go to "Network Share" at page 28.

---

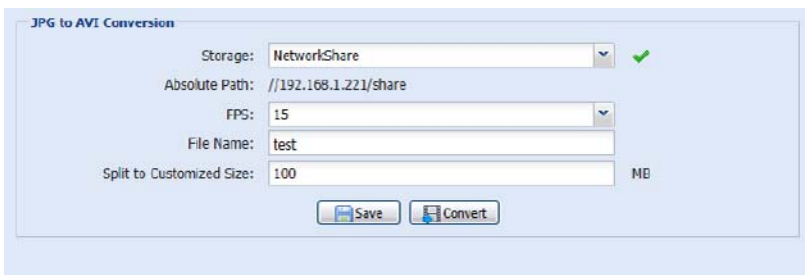

The screenshot shows the "JPG to AVI Conversion" configuration window. It includes the following fields and controls:

- Storage: NetworkShare (dropdown menu) with a green checkmark
- Absolute Path: //192.168.1.221/share (text input)
- FPS: 15 (dropdown menu)
- File Name: test (text input)
- Split to Customized Size: 100 MB (text input)
- Buttons: Save and Convert

Step1: Configure when to take snapshots in "Snapshot", and choose "Network Share" as the storage mode.

Step2: In "JPG to AVI Conversion", choose how many images you want to see per second in "FPS", name the video file, and specify the file size.

Step3: Click "Convert" to start file conversion, and go to the path specified to store snapshots in "Network Share" to check the video file.

## ■ 4.3.7 General

### General

To change the language of UI interface, select from the drop-down list in “Language”.

“Turbo Steps” is used to speed up one-click from 1 to 10. For example, if the value of the turbo step is set to 5, one mouse-click will function as 5 mouse-clicks when you click the arrow keys.

---

**Note:** When this function is enabled, the supported buttons will turn to red.

---

To lock camera access when it's not used after the specified time, select “5 MIN”, “15 MIN” or “30 MIN” from the drop-down list of “Auto Lock Time”, or select “NEVER” to disable this function.

---

**Note:** When the camera access is locked after the specified time, to resume camera access, please enter the password.

---

General Configuration

Language: English

Turbo Step: 5

Auto Lock Time: 15 MIN

MAC Address: 00:0E:53:EB:5B:50

Save Reload

### Time

Set daylight saving time and the current time, and click “Save” to confirm.

Time Configuration

OSD:  Enable  Disable

Date: 2011/08/30

Time: 21 : 16 : 41

Save Reload

Daylight Saving Time Configuration

Daylight Saving Time:  Enable  Disable

Start Time: August First Week Monday 6 : 0 (HH:MM)

End Time: October Fifth Week Monday 10 : 0 (HH:MM)

Adjust Time: 1 : 0 (HH:MM)

Save Reload

Function	Description
<b>■ Time Configuration</b>	
Date	Set the current date.
Time	Set the current time.
<b>■ Daylight Saving Time Configuration</b>	
Daylight Saving Time	Specify whether to use daylight saving time (Enable / Disable).
	If this function is enabled, set the time period (Start Time / End Time), and adjust the daylight saving time in hours (Adjust Time).

## Server Log

To quickly search the system logs you want by event type, click “Prev. Page” or “Next Page” to find the logs you want, or check the event type(s) and click “Reload” to start searching.

To clear all system event logs, click “Clear All”.

**Server Log List**

No.	Event	Time	Result
1	Remote Login	2011/08/30 20:54:41	admin
2	Remote Login	2011/08/30 20:29:58	admin
3	Remote Login	2011/08/30 18:22:08	admin
4	SNTP Update	2011/08/30 18:20:06	Failed
5	Remote Login	2011/08/30 18:20:03	admin
6	Power On	2011/08/30 18:19:24	ON
7	Power On	2011/08/30 18:18:46	OFF
8	Remote Login	2011/08/30 18:11:21	admin
9	Remote Login	2011/08/30 18:11:18	admin
10	Remote Login	2011/08/30 18:07:10	admin
11	Remote Login	2011/08/30 18:03:19	admin
12	Remote Login	2011/08/30 18:02:15	admin
13	Remote Login	2011/08/30 18:02:07	admin
14	Remote Login	2011/08/30 18:01:51	admin
15	Remote Login	2011/08/30 17:57:01	admin
16	Remote Login	2011/08/30 17:56:55	admin
17	Remote Login	2011/08/30 17:56:53	admin
18	Remote Login	2011/08/30 17:54:44	admin
19	SNTP Update	2011/08/30 17:50:48	Failed
20	Power On	2011/08/30 17:50:07	ON

◀ Prev. Page   ▶ Next Page   ↻ Reload   🗑 Clean All

## Online

You can check the current online user(s) with respective online information. To refresh the list, click “Reload”.

- To allow anonymous login, select “Enable” in “Anonymous Viewer Login”.
- To disable image code verification at login, select “No” in “Login with CAPTCHA Image”.

**Online Configuration**

Anonymous Viewer Login:  Enable  Disable

Login with CAPTCHA Image:  Yes  No

Max Online User:

Username	IP Address	User Level	Media Type
admin	211.75.84.96	SUPERVISOR	H264
admin	60.248.97.4	SUPERVISOR	H264

↻ Reload

Save   Reload

## **Account**

You can create a new account with different user access privilege, or delete or modify an existing account setting.

### **How to create a new account**

Step1: Click “New”, and fill in the following columns.

The screenshot shows a web interface for account management. At the top, there is a table with columns 'Username', 'User Level', and 'Life Time'. The table lists accounts: 'admin' (SUPERVISOR, INFINITE), 'power' (POWER USER, 1 HOUR), 'normal' (NORMAL, 1 HOUR), and 'guest' (GUEST, 1 HOUR). A 'New Account Info' dialog box is open in the center, with the following fields: Username: 'office', Password: '\*\*\*\*\*', Confirm Password: '\*\*\*\*\*', User Level: 'POWER USER' (dropdown), and Life Time: '1 HOUR' (dropdown). At the bottom of the dialog are 'Save' and 'Close' buttons. At the bottom left of the main interface, there are 'Add', 'Edit', and 'Delete' buttons. A red arrow points to the 'Add' button.

Column	Description
User Name	Set a user name that will be used for camera access. The user name allows up to 16 alphanumeric characters.
Password	Set the password that will be used for remote login. The password allows up to 16 alphanumeric characters.
Confirm Password	Enter the password again to confirm.
User Level	Set the security level of an account to give the permission to control different functions. There are four user levels: SUPERVISOR, POWER USER, NORMAL USER and GUEST.
Life Time	Select how long this account is allowed to stay online (1 MIN / 5 MIN / 10 MIN / 1 HOUR / 1 DAY / INFINITE)

Step2: Then, click “Save” to save your setting and create a new account.

### **How to modify or delete an existing account**

Step1: Select the account you want to modify or delete.

Step2: To modify the account, click “Edit” to change the settings, and click “Save”.

To remove the account, click “Delete”.

---

**Note:** It's not allowed to remove an account when there's only one account in the account list.

---

## Google Maps

This function is used to let you know where the camera is.

The system will prompt you to apply a Google Maps Key if your access is denied. Please follow the instructions below when you're denied:

Step1: Click "Sign up for a Google Maps key" to enter the application page.

Step2: Check the terms and conditions, and enter the IP address of the camera. Then, click "Generate API Key".

Step3: Copy the generated API key, and click "Update Google Maps Key" on the web browser to paste it.

The screenshot displays the Google Maps web interface. On the left, the 'Device Location' panel contains the following information:

- Latitude: 25.040076746689472
- Longitude: 121.51211500167846
- Zoom: 5

Below the location fields, there is a link 'Sign up for a Google Maps key' and a button 'Update Google Maps Key'. The main map area shows a view of East Asia, with a red location pin placed on the island of Taiwan. The map includes labels for various cities and regions in China, Japan, and Southeast Asia. At the bottom of the interface, there are 'Save' and 'Reload' buttons.

## **Maintenance**

### **Firmware Upgrade**

This function is used when users need to upgrade the camera for function scalability.

---

**Note:** Before using this function, make sure you have the correct upgrade files provided by your installer or distributor.

---

---

**Note:** The event videos saved in the camera will be removed after firmware upgrade. Make sure you've copied important events to your PC before firmware upgrade.

---

Step1: Select “” to browse to where you save the upgrade files, and select them one by one until all files are selected (up to four files).

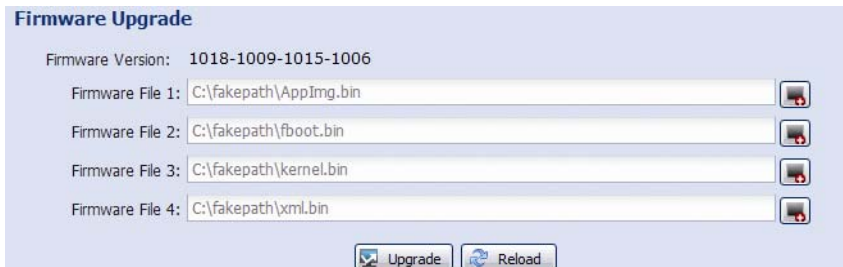

Step2: Select “Upgrade” to start system upgrading.

---

**Note:** You'll be prompted to keep current configurations. It's recommended to keep them, or all configurations will be restored to default values after upgrade.

---

---

**Note:** It takes a few minutes to finish the upgrade process. Do not disconnect the power during firmware upgrade, or the upgrade may be failed. The camera will reboot after the upgrade.

---

### **System Configuration Backup**

This function is used to copy your system configuration to a “System.bin” file.

You may import the same system configuration to another camera, or restore your system configuration when the camera is reset to default values.

Select “System.bin” in “Firmware Upgrade”, and select “Upgrade” to import the system configuration.

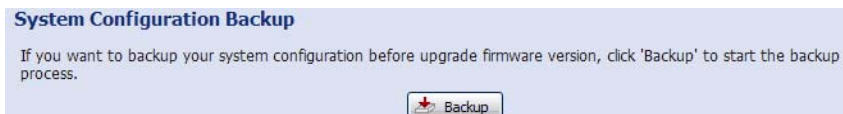

### **System Reboot**

Select “Reboot” to restart your camera if needed.

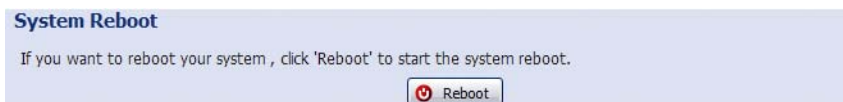

### **Player Download**

To see the event video clips downloaded to your PC, you need to first install our own video player in your PC.

Select “Free Download” to download the video player, and double click the file to install it.

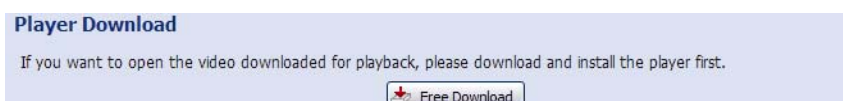

# SPECIFICATIONS\*

Camera Type	20X	30X	
<b>■ Network</b>			
LAN Port	YES		
LAN Speed	10/100 Based-T Ethernet		
Data Transmission Speed	10/100/1000 Based-T		
Supported Protocols	DDNS, PPPoE, DHCP, NTP, SNTP, TCP/IP, ICMP, SMTP, FTP, HTTP, RTP, RTSP, RTCP, IPv4, Bonjour, UPnP, DNS, UDP, IGMP, QoS, IEEE802.1X, SNMP		
ONVIF Compatible	YES (Profile S)		
Number of Online Users	10		
Security	(1) Multiple user access levels with password (2) IP address filtering (3) Digest authentication		
Remote Access	(1) Internet Explorer on Windows operating system (2) 16CH Video Viewer on Windows & MAC operating system (3) EagleEyes on iPhone, iPad & Android mobile devices		
<b>■ Video</b>			
Video Output	IP, TVI*, AHD* and CVBS		
Compression Format	H.264 (Main Profile) / MJPEG		
Video Resolution	1920 x 1080 / 1280 x 720 / 720 x 480 / 352 x 240		
Frame Rate	30 fps		
Multiple Video Streaming	4 (H.264, MJPEG)		
Bitrate Control	SVBR control (VBR + Max bitrate)		
<b>■ General</b>			
Image Sensor	1/2.8" Sony CMOS image sensor		
Min. Illumination	0.1 Lux / F1.6(Wide)~F3.5(Tele), 0 Lux (IR LED ON)	0.1 Lux / F1.6(Wide)~F4.4(Tele), 0 Lux (IR LED ON)	
Shutter Speed	1 / 60 (1/50) to 1 / 100,000 sec.		
S/N Ratio	More than 48dB (AGC OFF)		
Lens	f4.7 ~ 94mm / F1.6 (Wide) ~ 3.5(Tele) f4.5 ~ 135mm / F1.6 (Wide) ~ 4.4(Tele)		
Lens Angle	Horizontal	1X: 60.8° / 20X: 3.4°	1X: 60.8° / 30X: 2.5°
	Vertical	1X: 35.3° / 20X: 1.9°	1X: 35.3° / 30X: 1.4°
	Diagonal	1X: 68.3° / 20X: 3.8°	1X: 68.3° / 30X: 2.8°
IR LED	8 units		
IR Effective Distance	Default: Up to 200 meters / IR Turbo mode: More than 200 meters		
IR Shift	YES		
Smart Light Control	YES		
White Balance	Auto / 2500K / 3200K / 4200K / 5800K / 9500K		
AGC	YES		
IRIS Mode	YES		
Sharpness	YES		
WDR	YES (120dB)		
PoE	802.3at		
External alarm I/O	YES (1 input / 1 output)		
MicroSD Card Slot	YES (up to 64GB)		
RS485	YES		
IP Rating	IP66		
Operating Temperature	-20°C ~ 50°C		
Operating Humidity	90% or less relative humidity		



<b>■ General</b>	
Power Source (±10%)	AC 24V / DC19V
Current consumption (±10%)	DC19V / 1.3A
Power Consumption (±10%)	PoE & PoN: 30.2W; DC adapter: 25W   PoE & PoN: 29.3W; DC adapter: 25W
Net Weight (kg)	6.9
<b>■ Audio</b>	
Line in	YES (Mono)
Line out	YES (Mono)
<b>■ PTZ Mechanism</b>	
Pan Range	360° continuous rotation
Max. Pan Speed	90°/s
Tilt Range	-6° ~ 90°
Max. Tilt Speed	70°/s
Zoom Ratio	20X Optical Zoom   30X Optical Zoom
Max. Zoom Speed	Approx. 3s (Tele ~ Wide)
Preset Points	Up to 256 preset points
Sequence Group	1. Up to four groups can be set 2. One group can include up to 16 preset points
Auto Tracking	YES
<b>■ Others</b>	
Mobile Surveillance	iOS & Android
Event Notification	FTP / Email / SMS
Digital Pan / Tilt / Zoom	YES
Reset Default	YES
Motion Detection	YES
RTC (real-time clock)	YES
Minimum Web Browsing Requirements	<ul style="list-style-type: none"> <li>• Intel core i3 or higher, or equivalent AMD</li> <li>• 2GB RAM</li> <li>• AGP graphics card, Direct Draw, 32MB RAM</li> <li>• Windows 10, Windows 8, Windows 7, Windows Vista &amp; Windows XP, DirectX 9.0 or later</li> <li>• Internet Explorer 7.x or later (Windows Edge not supported)</li> </ul>
Optional Peripherals	USB Joystick

\* TVI and AHD output: 1.0 Vp-p composite, 75Ω

\*\*The specifications are subject to change without notice.

## MICRO SD CARD COMPATIBLE LIST

Manufacturer	Capacity	Class	Manufacturer	Capacity	Class
ADATA	2GB	--	Transcend	2GB	--
	4GB	Class 6		4GB	Class 2
Apacer	2GB	--		4GB	Class 4
	4GB	Class 4		4GB	Class 6
SanDisk	2GB	--		8GB	Class 6
	4GB	Class 4		16GB	Class 10
	8GB	Class 4	Kingston	2GB	--
	16GB	Class 4		4GB	Class 4
	32GB	Class 4		8GB	Class 4
Verico	2GB	--		32GB	Class 4
	4GB	Class 4		64GB	Class 10
	16GB	Class 10	TOSHIBA	16GB	Class 4
Silicon Power	64GB	--	TOPRAM	32GB	Class 10
	Kingmax	64GB		--	

# API ID APPLICATION FOR SMS MESSAGING

To allow the camera automatically sending a text message when an event happens, you need to apply an API ID from a mobile messaging company first, such as Clickatell or EVERY8D.

Below shows an example of how to get an API ID from Clickatell.

**Note:** The SMS messaging may not be totally free. Please check the charge policy of the messaging service you use.

**Note:** The instructions below are for reference only and may vary when Clickatell's official website is updated.

Please follow the steps below for application.

Step1: Go to <http://www.clickatell.com/login.php>. Sign up an account first.

**Login** [Click to create an account.](#)  
Which product would you like to log in to? [Don't have an account? Sign up here](#)

- Communicator2**  
Send bulk SMS via the internet. No programming needed.
- Developers Central**  
Reliable, scalable, customisable. Integrates with your system via APIs.
- Messenger Pro**  
Desktop, Bulk SMS solution.
- ICM**  
Campaign management for standard and premium-rate marketing campaigns.
- Affiliates**  
Advertise Clickatell and increase your earnings with our affiliate program.

Step2: Select "Developers Central", select the location where you want to use this service, and fill in your information to create an account.

Which product would you like to sign up for?

- Communicator2**  
Send bulk SMS via the internet. No programming needed.
- Developers Central**  
Reliable, scalable, customisable. Integrates with your system via APIs.

Which product is right for me? How much will it cost?

Where would you like to send messages to? **Check which one is suitable for you.**

- Anywhere in the World**  
**International** excl US Free signup  
I want to send fewer than 10,000 messages per month to the Americas
- Special Offers: One Country only** Why special?
  - South Africa** Free signup
  - UK** Free signup
  - Ireland** Free signup
  - India** Free signup

What is your first name? \*

What is your last name? \*

Which username would you like to use? \*

What is your mobile number? \*

What is your email address? \* [Privacy Policy](#)

Are you human? \*Please enter the words you see in the box, in order and separated by a space.

**Create your account**

Create my Account By clicking this button, you agree to Clickatell's [Terms and Conditions](#) >

Step3: When the account is created, the system will automatically send an Email to your specified Email address with the user name, password, and client ID used to log into the service.

Step4: Click the link within the email to log in, and you will be prompted to validate your mobile phone number. Select "SEND ACTIVATION CODE". The system will send an activation code to that number for verification.

Check if you receive a text message from Clickatell, and enter the activation code.

Verify your Mobile Number

For security reasons you are required to verify your mobile number in order to make your first credit purchase and send non-test SMS messages.

Your activation code will be sent to

If this is not your number, please retype your mobile number in the box above and click the "SEND ACTIVATION CODE NOW"

**Enter activation code here**

Enter your activation code once you have received it on your mobile phone:

Coupon Code:

Step5: In your account, find "Connection Status" and create a connection (API ID).

Note: Information on this page may be delayed by up to 1 minute.

**Account Status**

Credit Balance:

Payments Pending:

Credit Balance Alert: [Disabled](#)

Auto Billing: [Disabled](#)

SMS Bundle: [Disabled](#)

SenderID: [OK](#)

[View Daily Volumes](#)

**Message Delivery Status MT**

For period 15 April 2013 between 00:00 and 23:59 (GMT+2)

Messages delivered:

Messages failed:

Total:

[Click here](#) to view a detailed report.

**Connection Status**

**There are currently no connections in your account.**

[Click here to create a connection \(API ID\)](#)

**Click here**

**Message Delivery Status MO**

For period 15 April 2013 between 00:00 and 23:59 (GMT+2)

MO received:

[Click here](#) to view a detailed report.

Step6: Select "HTTP/S".

Connection Setup

Choose the connection that you would like to add to your account.

**HTTP/S** **Click "HTTP/S"**

popular connection, HTTP is one of the simpler ways to connect to the Clickatell API. It is used as an HTTP/Internet Post.

**SMTP (Email to SMS)**

Another firm favourite, the SMTP API allows messages that are sent via e-mail to be converted to SMS. Popular with customers who already have an e-mail messaging system in place.

Give a meaning name for this connection, and click "Submit and Get API ID".

Add Connection

HTTP API - Information entered during this step can be modified later.

Description:

**Give a name for this connection**

Required field

Replace Leading Zero (Dial Prefix)

Enable IP Address Restriction (IP Lock Down)

Enable SMS Status Notification (MT Callback)

**Click**

Step7: An API ID will be generated as follows.

---

**Note:** Note down the API ID for SMS notification setting later.

---

HTTP API

Your HTTP API connection was created successfully. Your connection is live ready for you to send SMS messages.

**API ID used for SMS**

API ID:

Description:

# PREREQUISITES FOR NETWORK SHARE

## Check PC IP Address

**Note:** The instructions below are taking Windows 7 and 8 for an example.

Step1: Go to "Network and Sharing Center", and select "Change adapter settings".



Step2: Right-click on "Local Area Connection", and select "Properties".

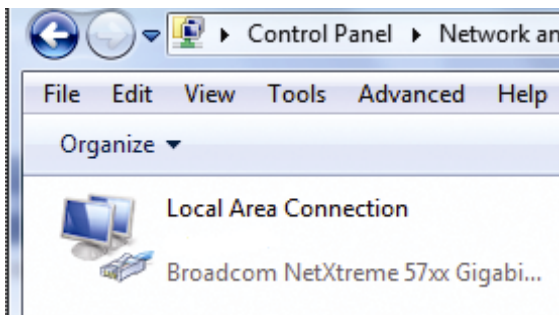

**Note:** If your local area connection is not enabled, please also enable it.

Step3: In the "Networking" tab, select "Internet Protocol Version 4 (TCP/IPv4)", and select "Properties".

Step4: In the "General" tab, note down the IP address in "Use the following IP address".

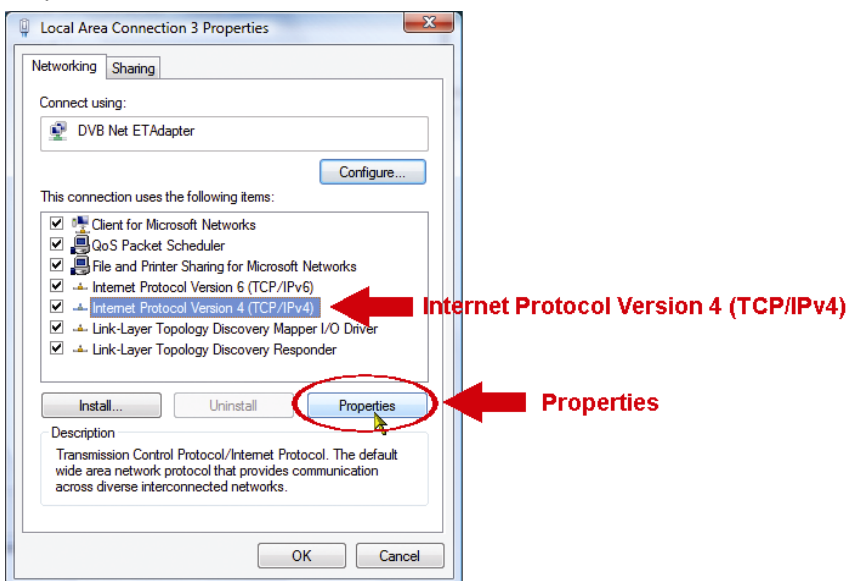

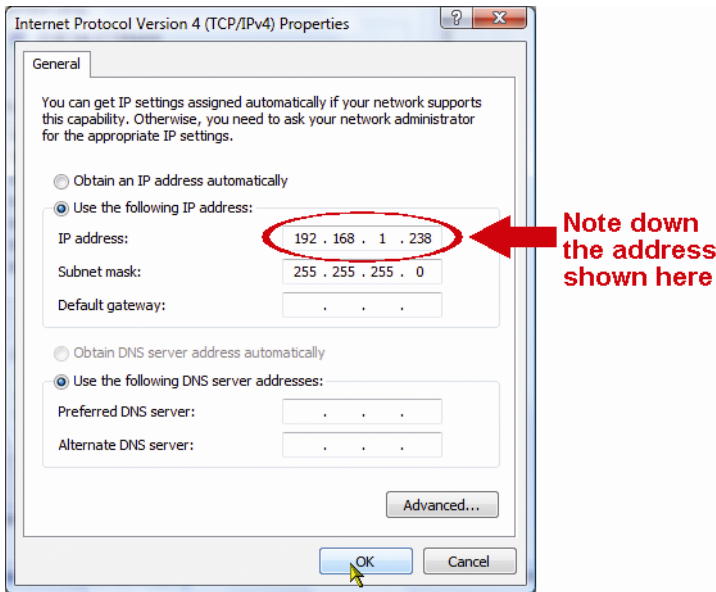

## Create "Administrator" Account

It's recommended to create a new administrator account on the PC for "Network Share" to use, or user could use the existing administrator account.

---

**Note:** The instructions below are taking Windows 7 and 8 for an example.

---

Step1: Go to "User Accounts" → "Manage Accounts", and select "Create a new account".

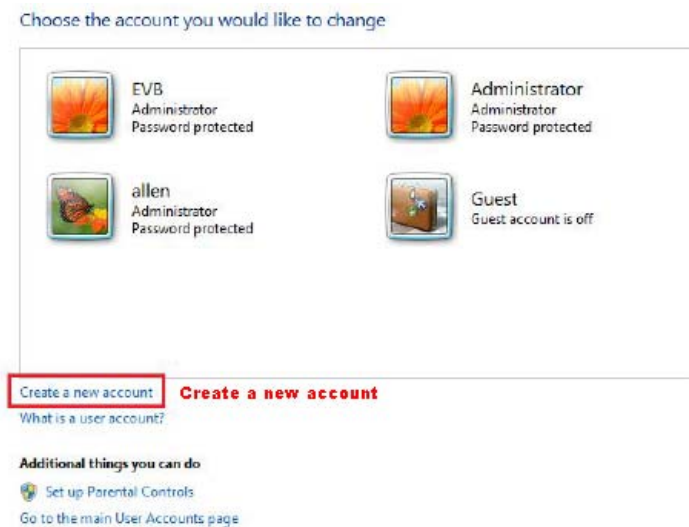

Step2: Set a user name, and choose "Administrator" for this account. Then, click "Create Account".

### Name the account and choose an account type

This name will appear on the Welcome screen and on the Start menu.

Office

Standard user

Standard account users can use most software and change system settings that do not affect other users or the security of the computer.

Administrator

Administrators have complete access to the computer and can make any desired changes. Based on notification settings, administrators may be asked to provide their password or confirmation before making changes that affect other users.

We recommend that you protect every account with a strong password.

[Why is a standard account recommended?](#)

Create Account

Cancel

Step3: Set the password, and click "Create Account".

### Create a password for Office's account



Office  
Administrator

You are creating a password for Office.

If you do this, Office will lose all EFS-encrypted files, personal certificates and stored passwords for Web sites or network resources.

To avoid losing data in the future, ask Office to make a password reset floppy disk.

••••

••••

If the password contains capital letters, they must be typed the same way every time.

[How to create a strong password](#)

Type a password hint

The password hint will be visible to everyone who uses this computer.

[What is a password hint?](#)

Create password

Cancel

## Share Folder

---

---

**Note:** The instructions below are taking Windows 7 and 8 for an example.

---

---

Step1: Right-click the folder you want to use to save snapshots for "Network Share", and choose "Properties".

Step2: In "Share Properties", select the tab of "Sharing", and choose "Share...".

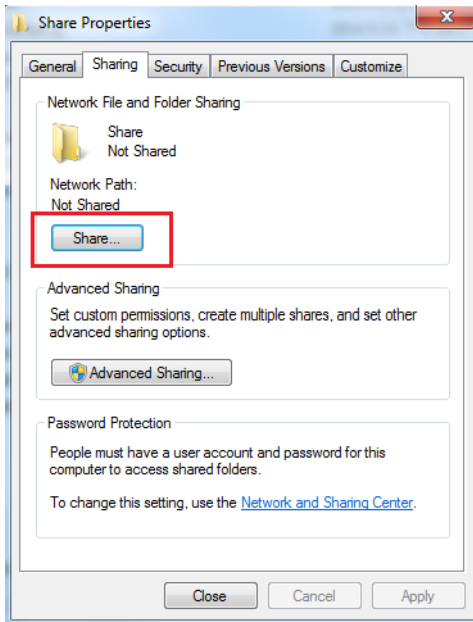

Step3: Choose the account you want to share with, and click “Share” to save.

